

Assembly Instructions

1.2m Wood Picnic Table

WPT001-01-270422



Contents:

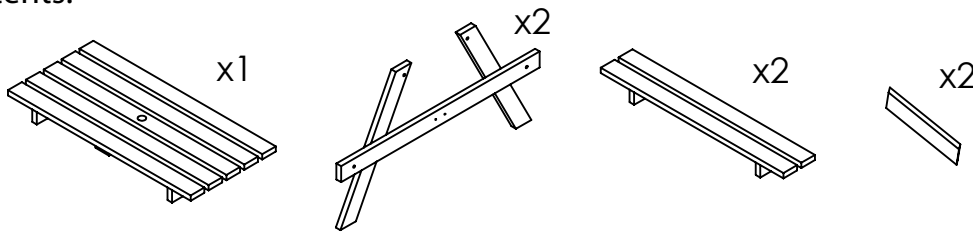

Fixings	QTY
M10x80mm Bolt	8
M10 Nut	8
M10 Washer	16
50mm Wood Screw	8

Tools Required: Combi/Power Drill, 17mm Spanner

Step 1: Lay the tabletop on a soft surface and bolt the a-frames to the tabletop using x4 M10x80 bolts.

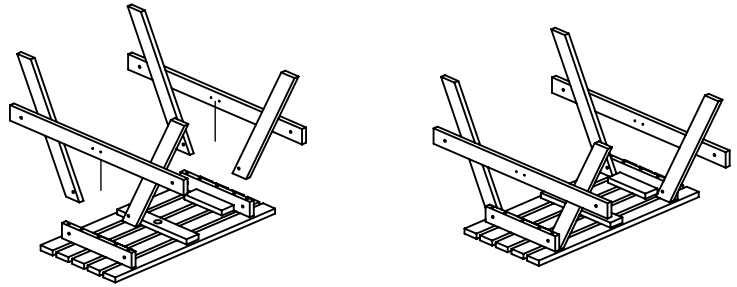

Step 2: With at least two people, flip the table the right way up and bolt the seats into the a-frames.

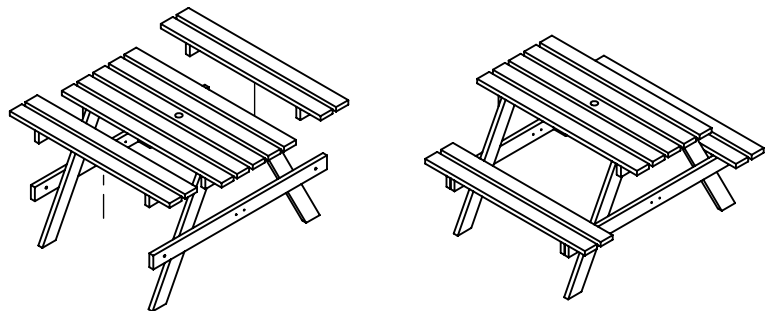

Step 3: Flip the table again and screw the diagonals into the a-frame crossbars and the middle table support.

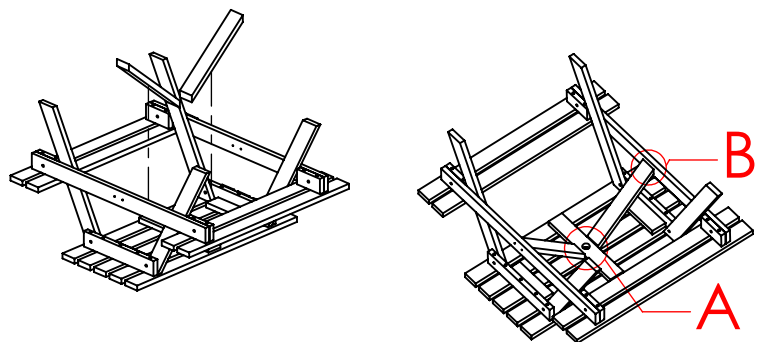
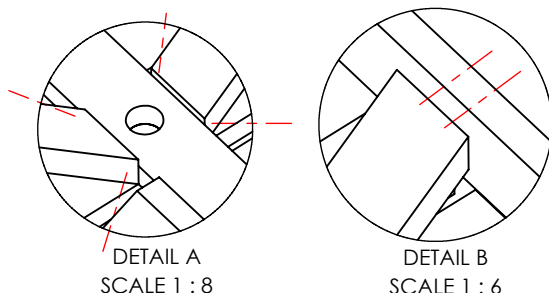

Maintenance:

15 years guarantee.

If damaged, repair and treatment is required.

Can be cleaned with soapy water.

Dependent on environment, more frequent treatment may be required.

Pressure treated tanalised timber (Class 4, BS EN 335-1 for direct contact with soil and fresh water).

Tel: 0800 1777 052 • Email: sales@nobutts.co.uk • Web: nobutts.co.uk

THANK YOU FOR YOUR BUSINESS