

DorMag SmartSound Userguide

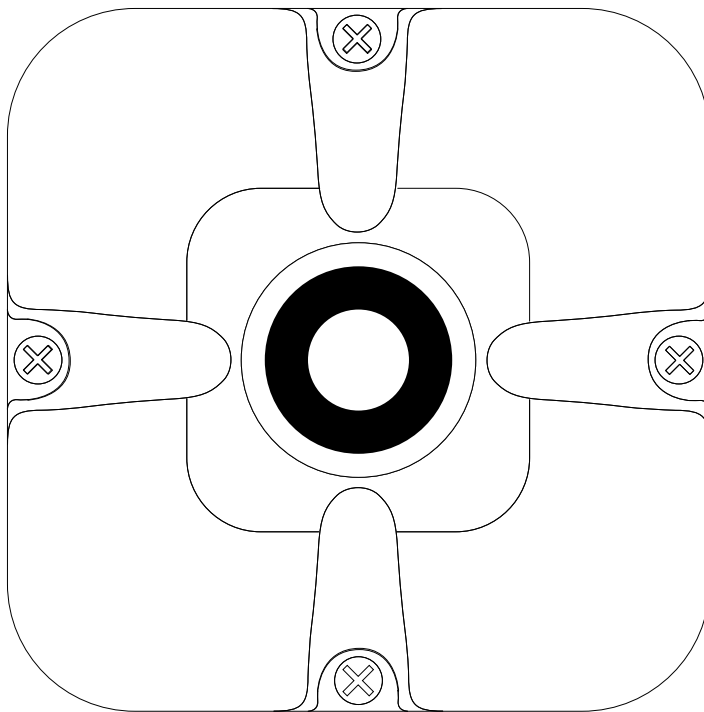

Sensitivity adjustment

Adjust the sensitivity of the unit to either increase or decrease the volume at which your DorMag SmartSound will release to.

For example, if your DorMag SmartSound is not releasing to the fire alarm sounder, it is likely that the sensitivity needs to be increased. If your DorMag SmartSound is going off to background noise you may need to decrease the sensitivity of the unit.

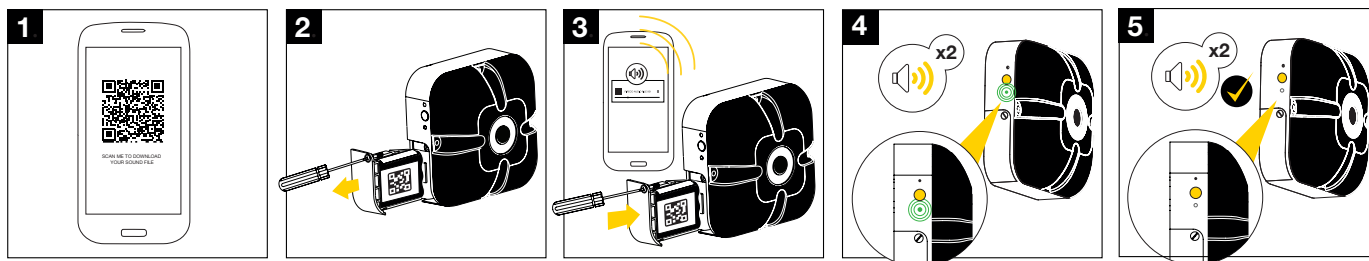

1. Using your smart phone, go to fireco.click/3237 or scan the QR code to take you to the sensitivity adjustment folder. Select which adjustment you require and download the sound file
2. Remove the battery carrier using a flat-head screwdriver and wait 10 seconds to let DorMag SmartSound fully power down
3. Press play on the sound file with the phone next to the unit. Whilst the sound file is playing re-insert the battery pack and fasten
4. The DorMag SmartSound will boot-up and beep twice. Its LED will go solid for a few seconds
5. The LED then switch off and the DorMag SmartSound will beep twice again to confirm the audio command has been accepted ✓



fireco.click/3237

Filter out short alarms

Adjust your unit to close the door after an alarm has been going off for a certain amount of time.

For example, schools often use the same sounder for fire alarms (which last for a long time) and lesson change bells (which last only for a few seconds). This feature allows shorter alarm sounds to be ignored so that the door remains open and only closes on the real fire alarm.

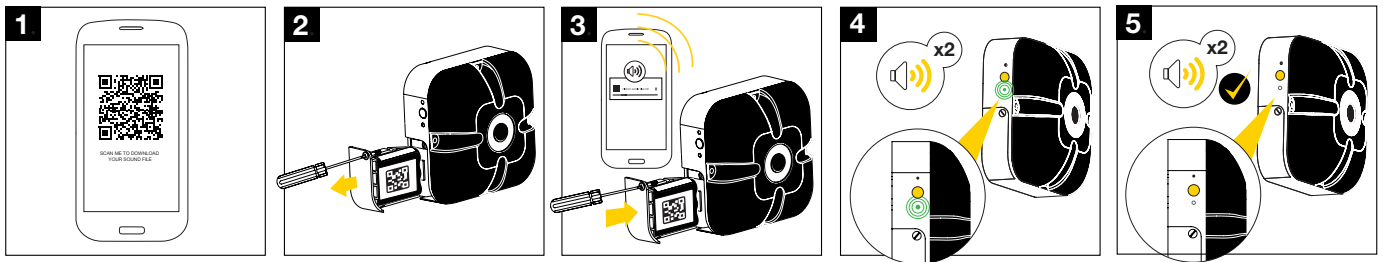

1. Using your smart phone, go to fireco.click/9740 or scan the QR code to download the sound file
2. Remove the battery carrier using a flat-head screwdriver and wait 10 seconds to let DorMag SmartSound fully power down
3. Press play on the sound file with the phone next to the unit. Whilst the sound file is playing re-insert the battery pack and fasten
4. The DorMag SmartSound will boot-up and beep twice. Its LED will go solid for a few seconds
5. The LED then switch off and the DorMag SmartSound will beep twice again to confirm the audio command has been accepted ✓



Delay door closure

Give people more time to evacuate the building before the doors close.

This is particularly useful if there are occupants who are disabled or have limited mobility.

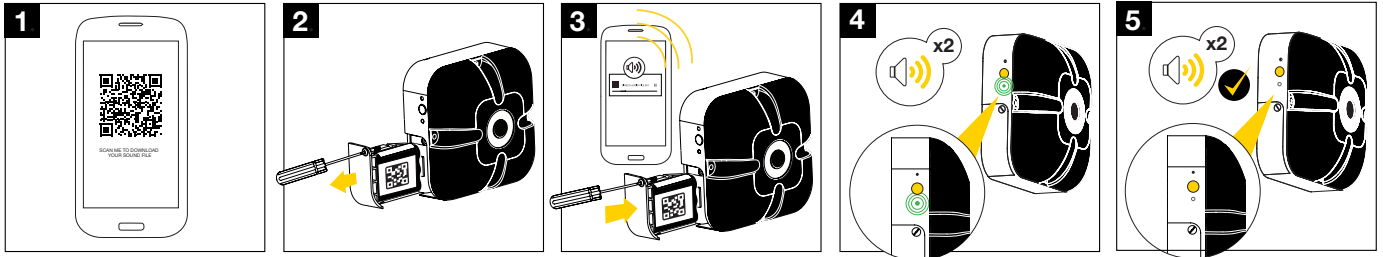

1. Using your smart phone, go to fireco.click/3690 or scan the QR code to download the sound file
2. Remove the battery carrier using a flat-head screwdriver and wait 10 seconds to let DorMag SmartSound fully power down
3. Press play on the sound file with the phone next to the unit. Whilst the sound file is playing re-insert the battery pack and fasten
4. The DorMag SmartSound will boot-up and beep twice. Its LED will go solid for a few seconds
5. The LED then switch off and the DorMag SmartSound will beep twice again to confirm the audio command has been accepted ✓



Timed release

Set the unit to close the door at a chosen time.

This is useful for hotels where doors need to be kept open during the day to allow easy access but closed at night to reduce noise.

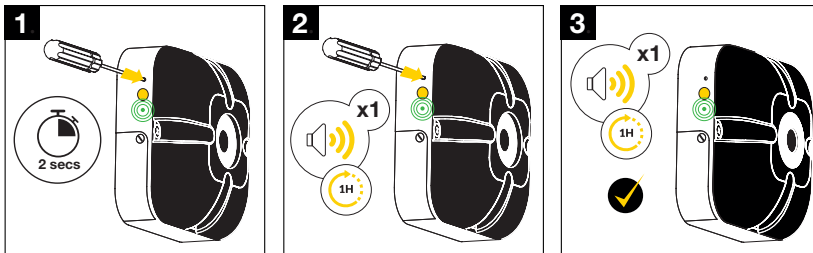

1. Insert a small screwdriver or equivalent into the hole next to the yellow button and press the recessed button for 2 seconds
2. The unit will beep once for every hour from the current time. E.g. If the time is 4pm and you want the unit to close the door at 8pm, you need to let the unit beep 4 times before pressing the button again
3. The unit will beep back the number of hours you have set to confirm ✓

To change the time you have set, follow steps 1-3.

Notes: If you are applying other features, set the Timed release feature last. Every time the device reboots, it will lose this functionality.

Disable the unit

If you want to disable your DorMag SmartSound, so that it cannot retain the door, follow these steps.

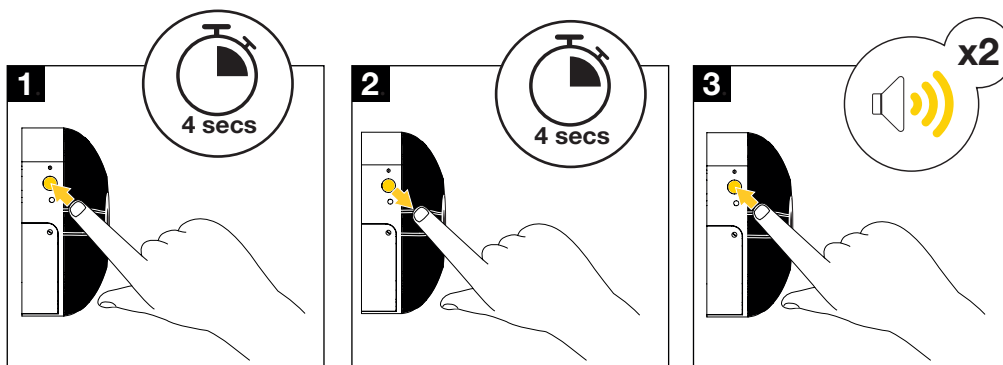

1. Push and hold the button on the front of the unit for 4 seconds (ignore the beeping)
2. Release the button for 4 seconds
3. Push and hold the button until the unit beeps twice
4. The magnet will stay retracted (disabled mode activated)

Note: Follow steps 1-3 to re-enable the unit to retain the door.

Factory reset

By factory resetting your unit, all features applied will be removed.

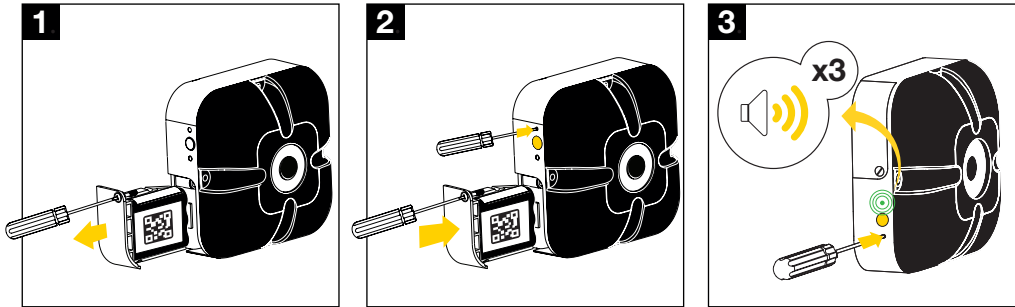

1. Remove the battery carrier using a flat-head screwdriver and wait 10 seconds to let DorMag SmartSound fully power down
2. Whilst holding down the recessed button using a small screwdriver or equivalent re-insert the battery carrier - this must be done simultaneously
3. Continue to hold the button until the unit beeps 3 times to confirm the reset ✓

DorMag SmartSound troubleshooting

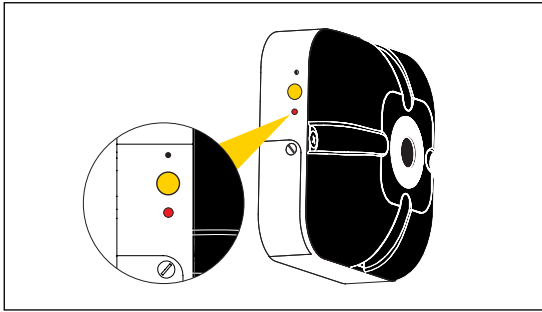

Battery levels:

Upon insertion of battery pack:

- Green for 5-10 seconds if brand new batteries are inserted
- Amber for 5-10 seconds if batteries have less than 20% charge remaining
- Red for 5-10 seconds when critical battery level is reached. The unit will fail-to-safe. This can also happen during normal operation, once batteries are depleted

Fire alarm active:

- Flashes red and beeps for 8 seconds before door is released upon detection of an alarm

Timed release:

- Flashes green and beeps for 8 seconds before door is released, if timed release feature is in use

Manual release (when pressing yellow button):

- Flashes red and beeps for 8 seconds before door is released

Faults:

- LED off with a constant beep-beep noise: The battery carrier is not fully inserted. Re-insert the battery carrier
- Solid red LED with a constant beep-beep noise for 20 seconds, then the LED and buzzer turn off:
Potential system fault. Please contact Fireco Customer Support on 01273 320650

DorMag SmartSound specifications

Power	4.5V Lithium Iron Disulfide (Li/FES2) battery pack
Colour	Black with silver band
Warranty	2 years
Casing	ABS / ABS+PC plastic
Weight	0.52kg
Installation position (DorMag SmartSound)	On the wall adjacent to the door, with the DorMag SmartSound magnet fully centred with the keeper plate
Installation position (door keeper)	Anywhere on the back of the door
Max door to wall depth (when door is fully opened adjacent to the wall)	95mm (keeper chain or floor bracket required for greater distances)
Max door to wall angle (when door is fully opened adjacent to the wall)	Plus or minus 25° from parallel
Minimum door to wall angle (when door is closed)	65°
Hold open positions	Can hold the door open at any angle (dependant on add-ons, i.e. floor bracket & keeper chain)
Activation	SmartSound listening technology
Audible warning	Yes
Maximum door size	Power size 5 (max of 100kg and 1250mm width)
Fire rating	DorMag has been tested to EN1634-1 on FD30 doorsets, exposed and unexposed faces
Compliant to	EN1155:1997+A1:2002, EN1634-1:2008, EMC Directive, Radio Equipment Directive, UN 38.3 Lithium certification, CE Marked, UKCA Marked
Classification	Standard (category B) installations under BS 7273-4:2015+A1:2021
Part numbers	843-4317 DorMag SmartSound
DorMag SmartSound dimensions:	
Width	111mm
Length	111mm
Depth	53mm
Door Keeper dimensions:	
Width	61 mm
Length	61 mm
Depth	42.5mm

It is never safe to wedge open a fire door. If you need to buy more DorMag SmartSounds, give us a call on **01273 320650**