

Assembly Instructions

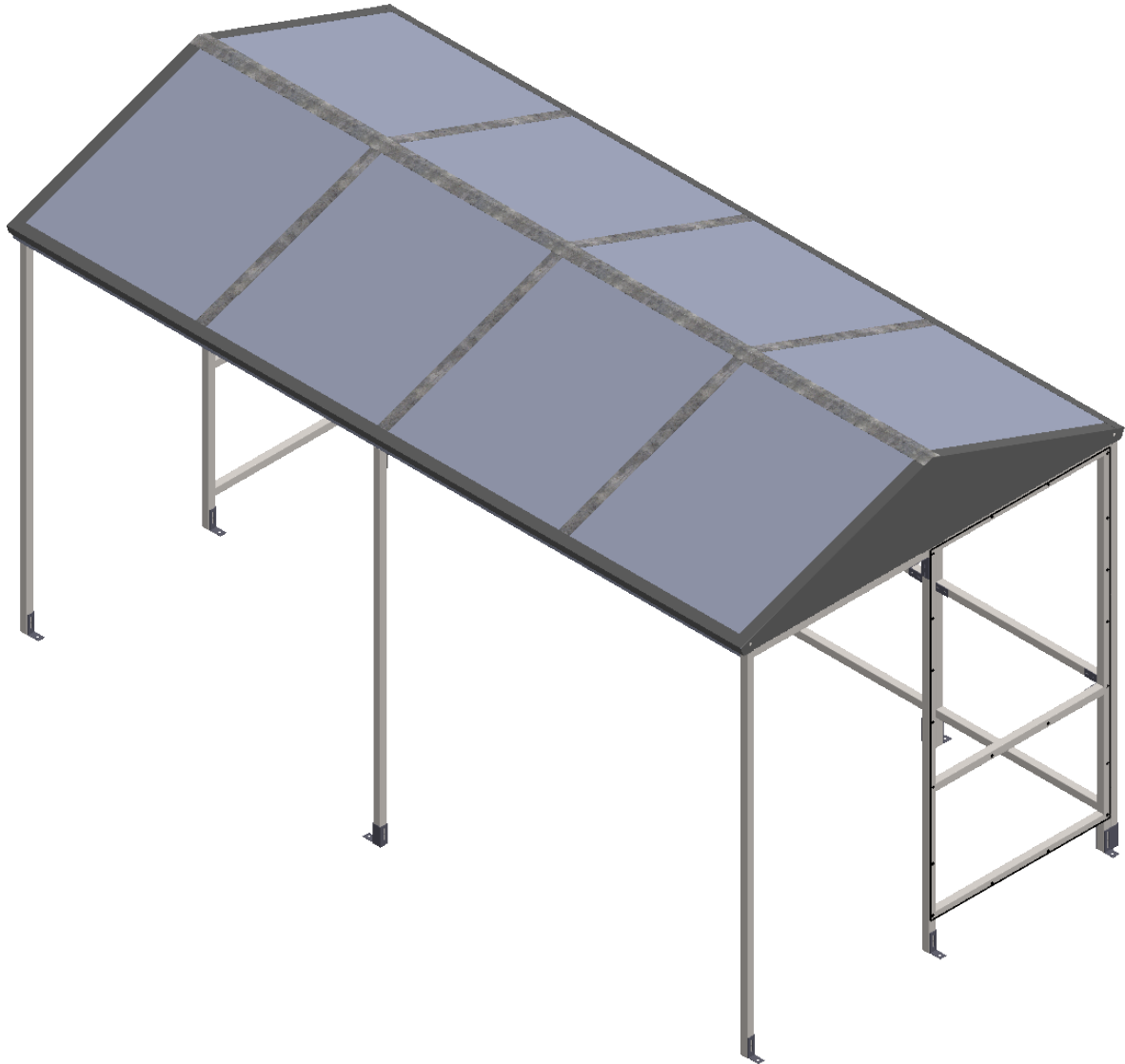

Email : sales@nobutts.com
Web : www.nobutts.com
Tel : 1-888-662-8887







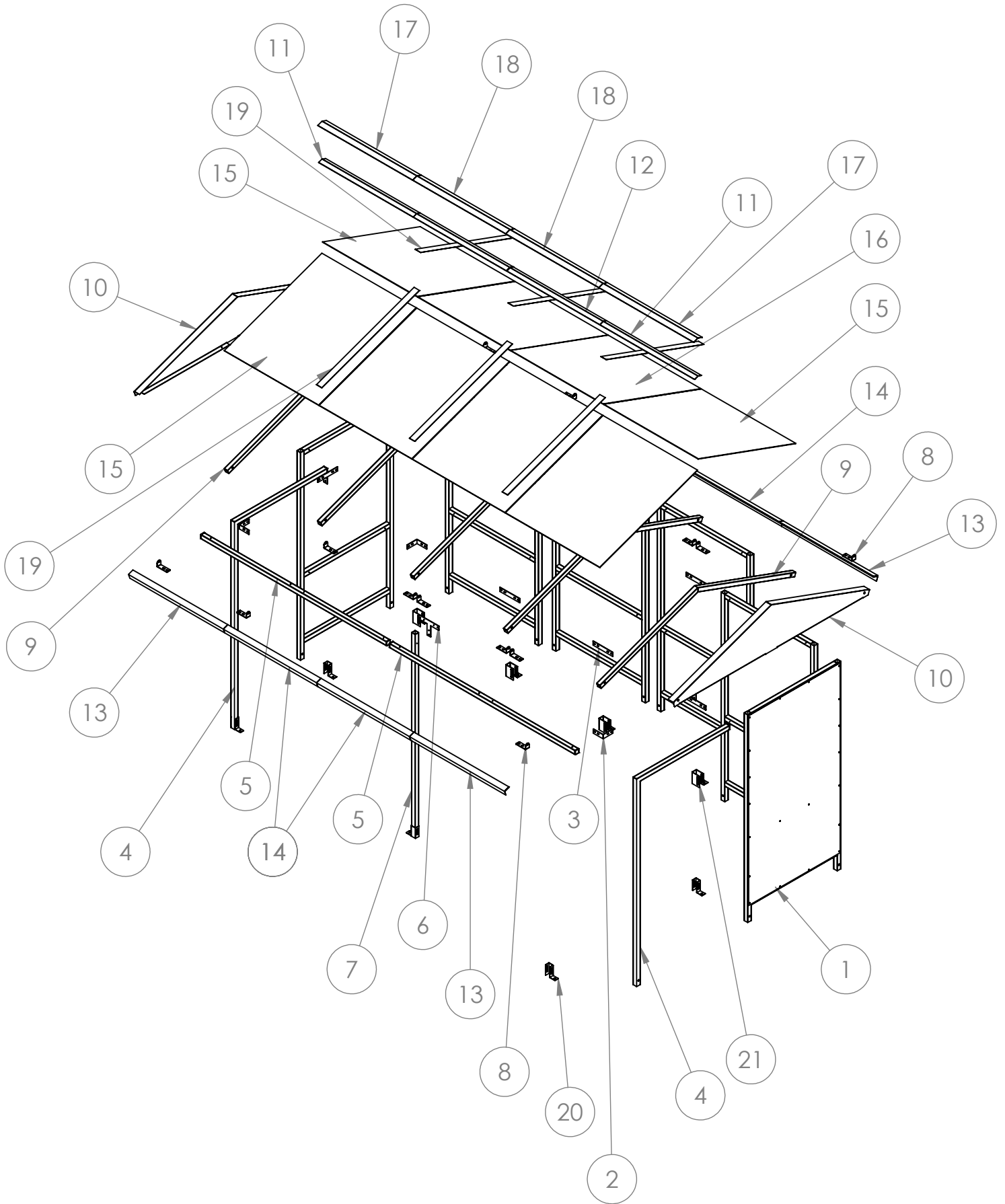



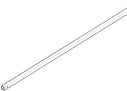
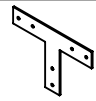

Shelter type: SR8306-F

SR8306F-01-22102021-USA

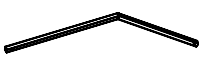
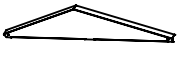
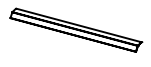
EXPLODED VIEW

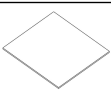
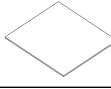
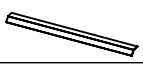
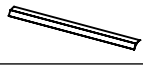
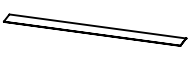

PARTS LIST

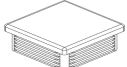
ITEM NO.	PART NAME	DRG NUMBER	Size (inch)	IMAGE	QTY.
1	S1C Frame	S1C	78.74 x 40.74		6
2	CB1 Bracket	CB1	4.3 x 4.3 x 1.57		8
3	JF1 Bracket	JF1	4.33 x 1.57		8
4	P1 Post	P1	78.74 x 40.74		2
5	ST3 Roof Tie	ST3	81.1 x 1.57 x 1.57		2
6	JFT	JFT	8.66 x 5.9		1
7	Post P5	P5	77.15 x 1.57 x 1.57		1
8	DR Bracket	DR	4.3 x 1.6 x 2		16
9	AR2R 2m Pitch Rafter	AR2R-02	85.75		5
10	AR2IS 2m Pitch Infill Panel Shallow	AR2IS-02	85		2
11	Roof centre lower trim outer	AR2CLTO-03	41.4		2
12	Roof centre lower trim inner	AR2CLTI-02	40.74		2
13	Roof F Section Outer	ARFSO	41.5		4
14	ARFSI Apex Roof F Section Inner	ARFSI	40.75		4
15	AR2POA AR2 Roof Panel outer ALU	AR2POA	45.5 x 41.3		4
16	AR2PIA AR2 Roof Panel inner ALU	AR2PIA	45.5 x 40.5		4
17	Roof centre upper trim outer	AR2CUTO-02	41.5		2
18	Roof centre upper trim inner	AR2CUTI	40.75		2
19	AR2TS 2m Apex Roof Trim strip	AR2TS-01	45.5 x 2.3		6
20	FT1 Bracket	FT1	1.57 x 1.57 x 3.94		5
21	FT3 Bracket	FT3	1.57 x 3.15 x 4.17		5
22	40x40 Plastic End Cap	EC40	1.6 x 1.6		6

FIXINGS / TOOLS

Fittings	Bolt set M10			T25	T38		BTANCM12100
	M10 x 60mm	Nut	Washer	1" Tech screw	1.5" Tech screw	Black Caps	M10/12 x 100 mm Concrete Bolt
Pack A+B	33	33	66	136	40	66	11
Image							



Drill/Screwdriver

Tools required:



17mm Wrench



Mallet



T25 Torx bit

Step 1 Assemble **S1C** frames to make up the main structure using **CB1** brackets for the corners and **JF1** brackets for the straight joints. Attach the **P1** posts to the **ST3** Roof Ties, and fix these to the **P5** post using the **JFT** Bracket as shown below

Please note 1.5" Tec Screws are for roof panels only

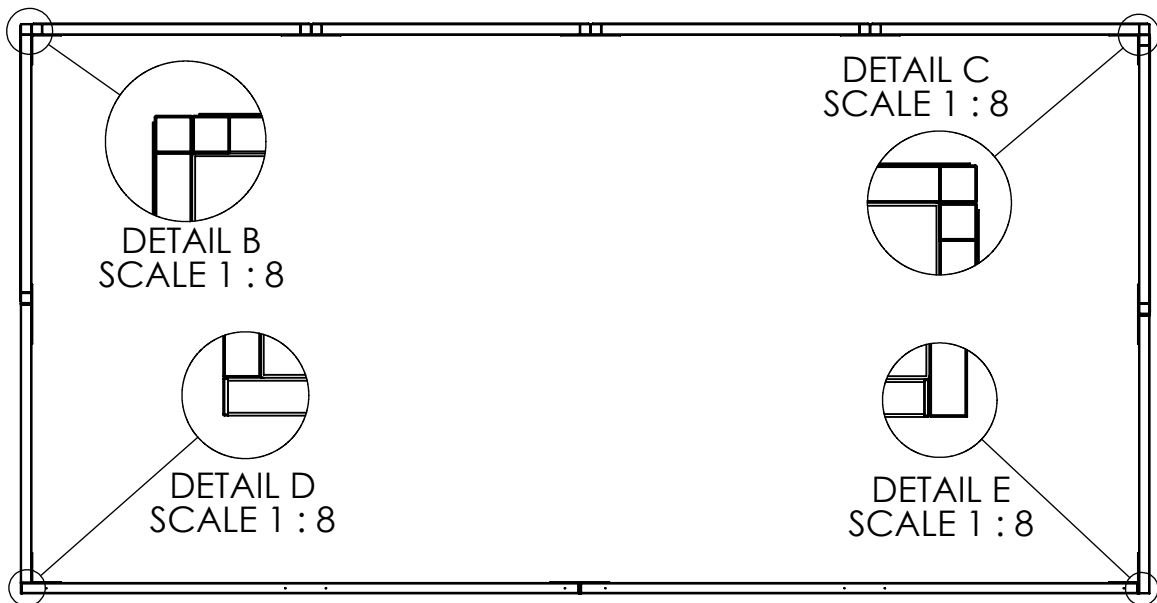
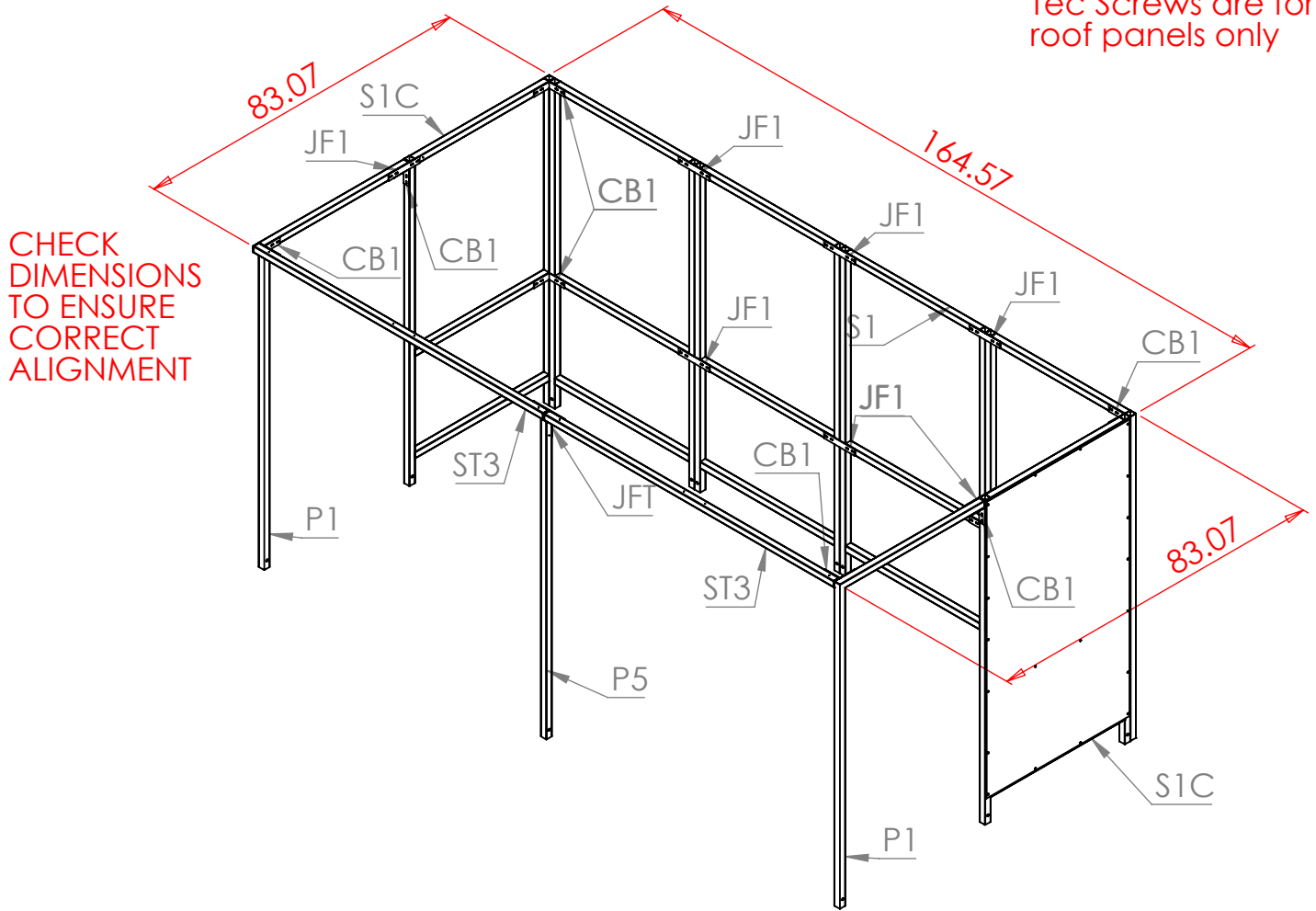

Step 2 Attach the **AR2R** Rafters using the **DR** Brackets. Screw the **AR2IS** End Panels into the top of the frames, ensuring they are put in place at the same time as the end rafters.

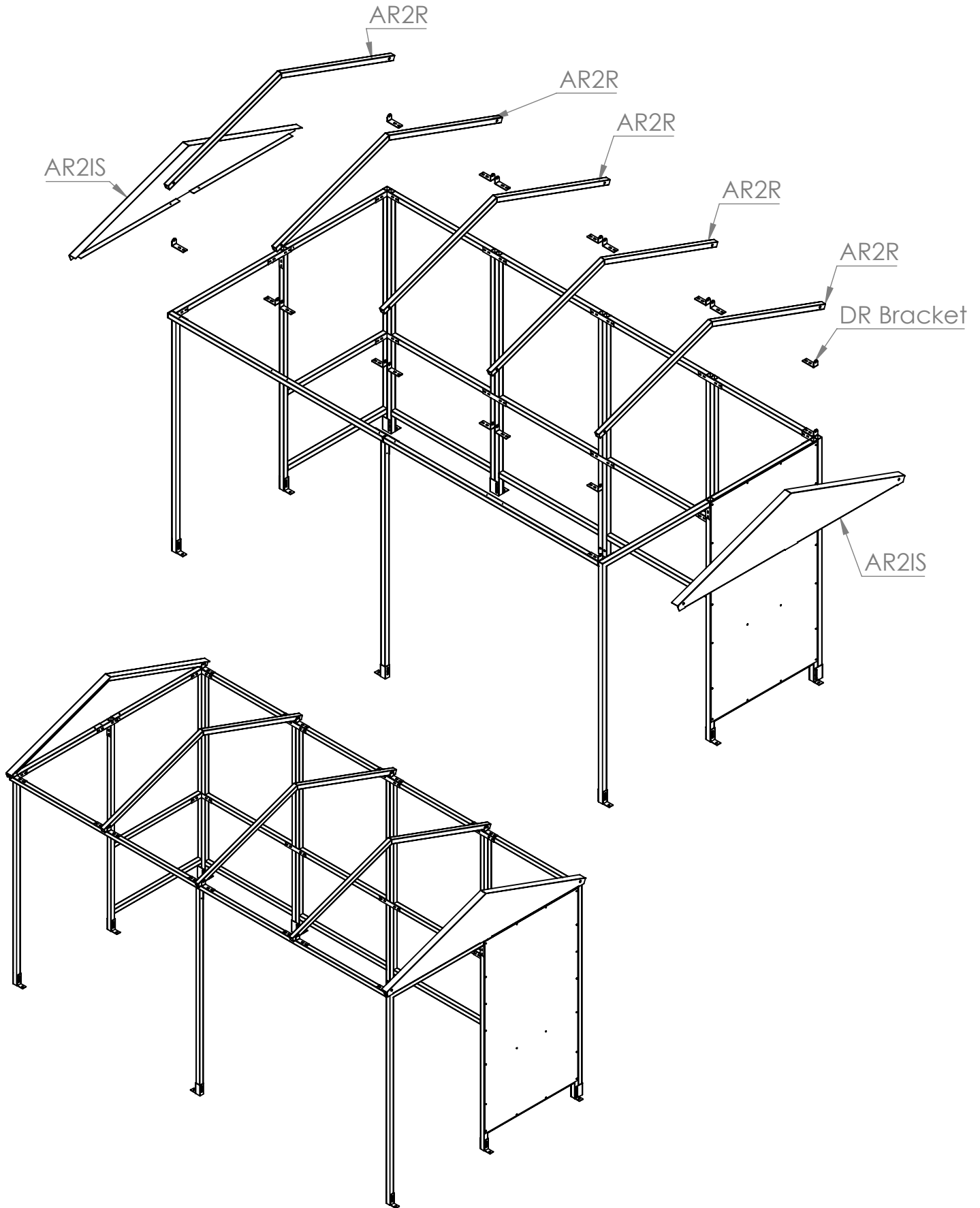

Step 3 Attach the **AR2CLTO** and **ARCLTI** trims to the top of the rafters, with the **AR2CLTO** on the edges, and the **AR2CLTI** spaced evenly in the middle. Attach the **ARFSO** and **ARFSI** to the bottom of the rafters with the **ARFSO** on the edges and the **ARFSI** spaced in the middle.

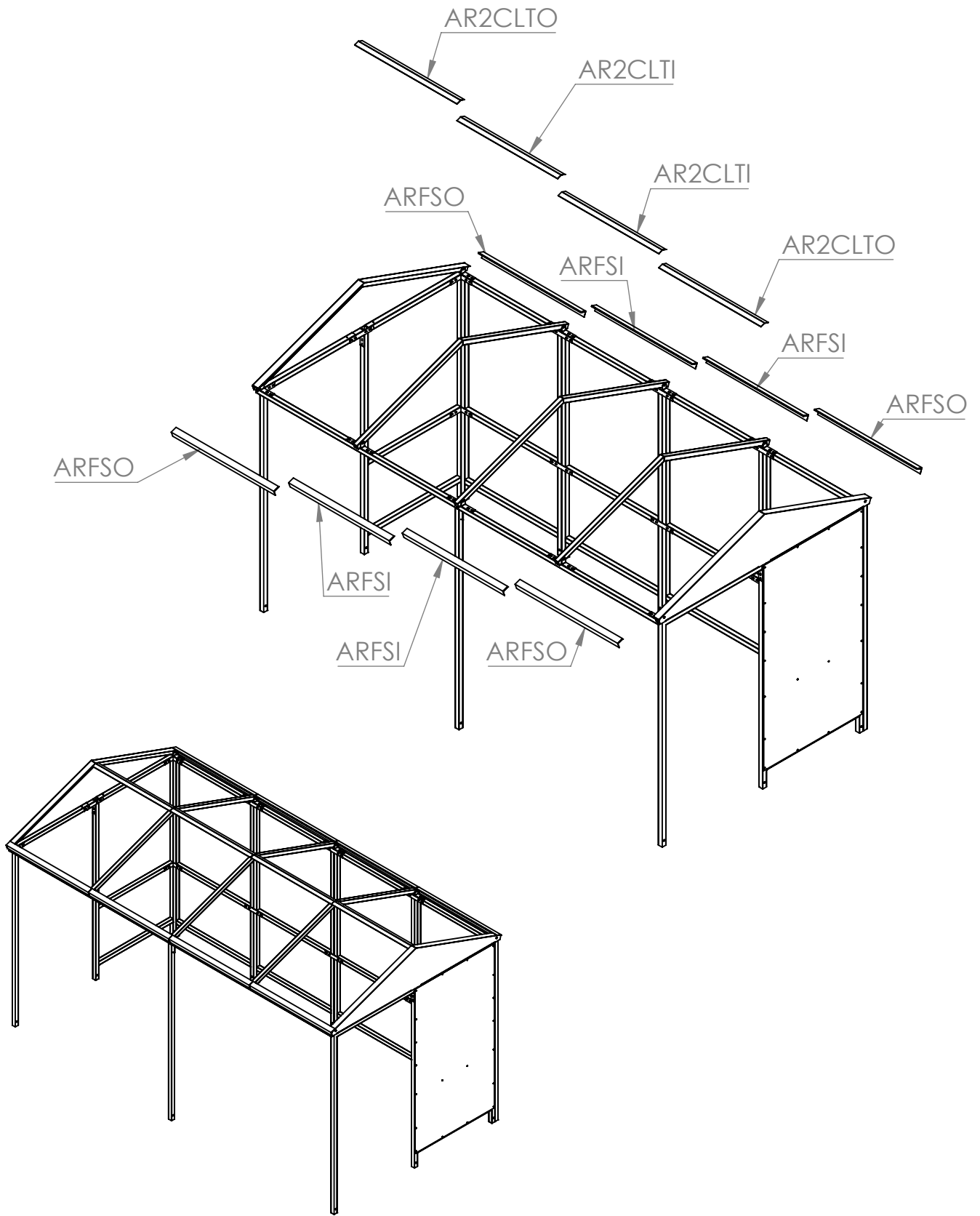

Step 4 Align the **AR2POA** roof panels with the outside of the shelter and space the **AR2PIA** panels central. Attach the **AR2TS** Strips, screwing through the roof panels. Fix the **AR2CUTO** and **AR2CUTI** to the top of the shelter as shown below.

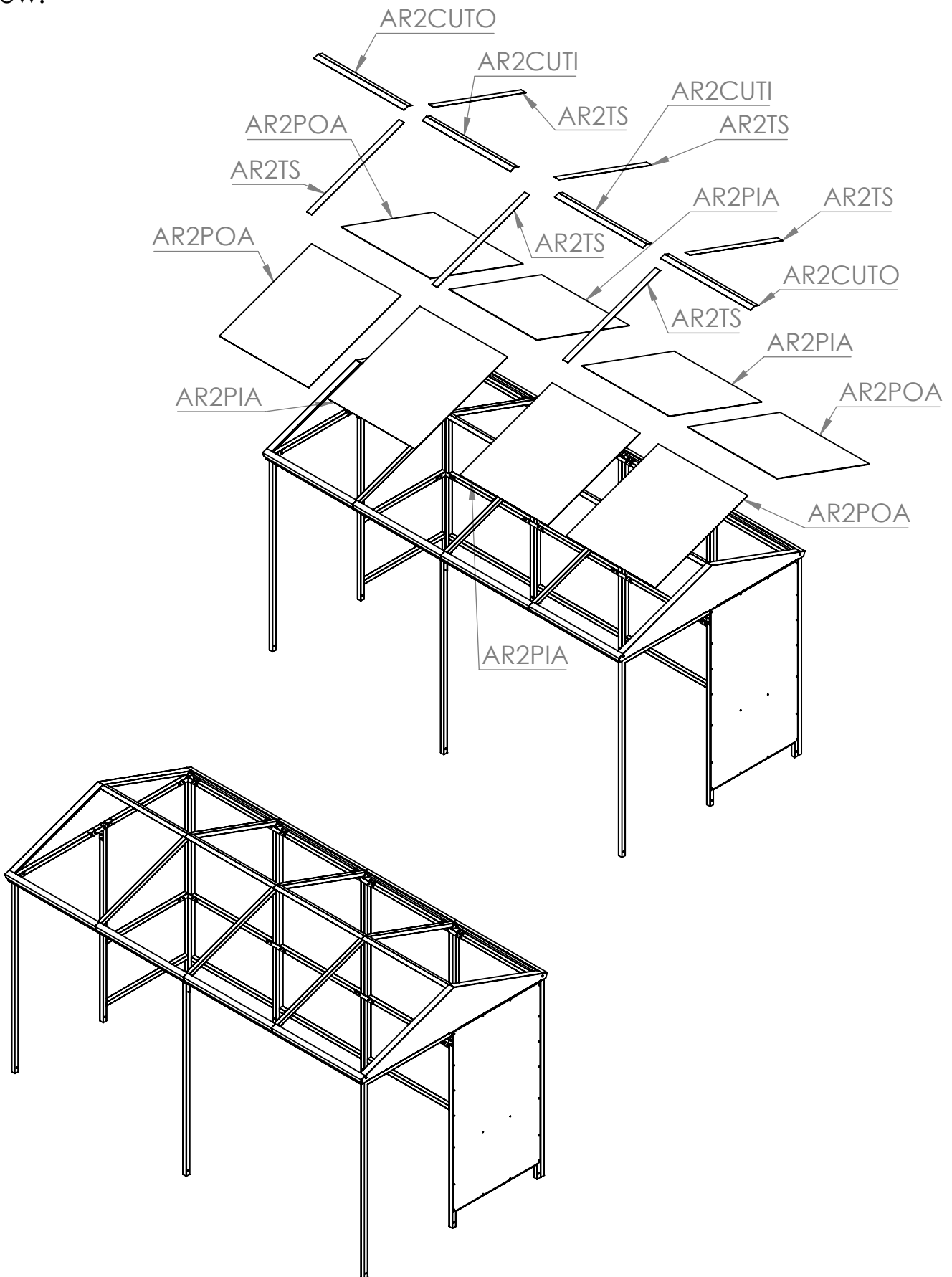

Step 5 Move the shelter to it's final position, and attach the **FT1** and **FT3** foot brackets. Fix the shelter to the ground using the anchor bolts.

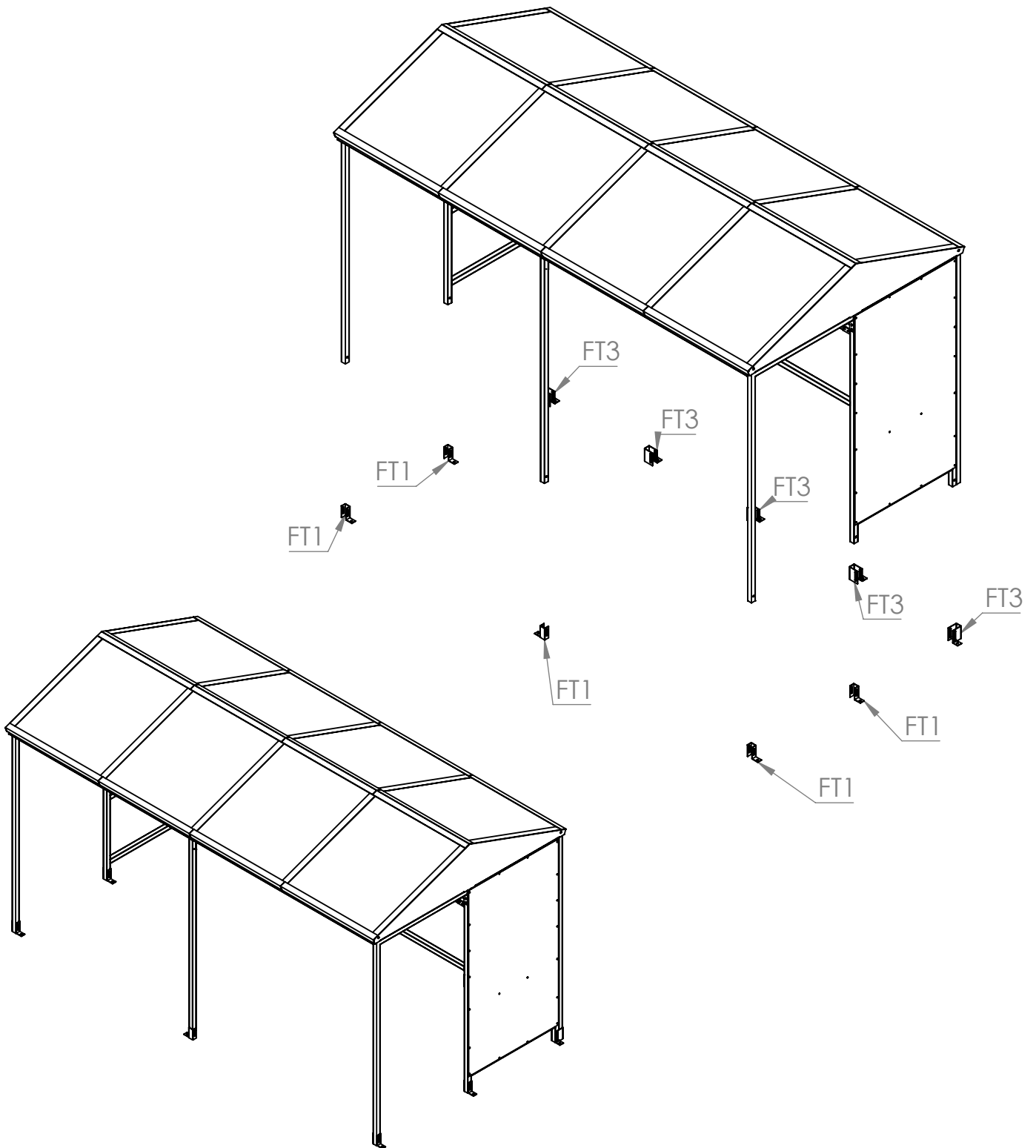

PLAN VIEW

OVERALL DIMENSIONS AND GROUND FIXING POSITIONS
Suggested size for concrete base: 8" oversized on all four sides.

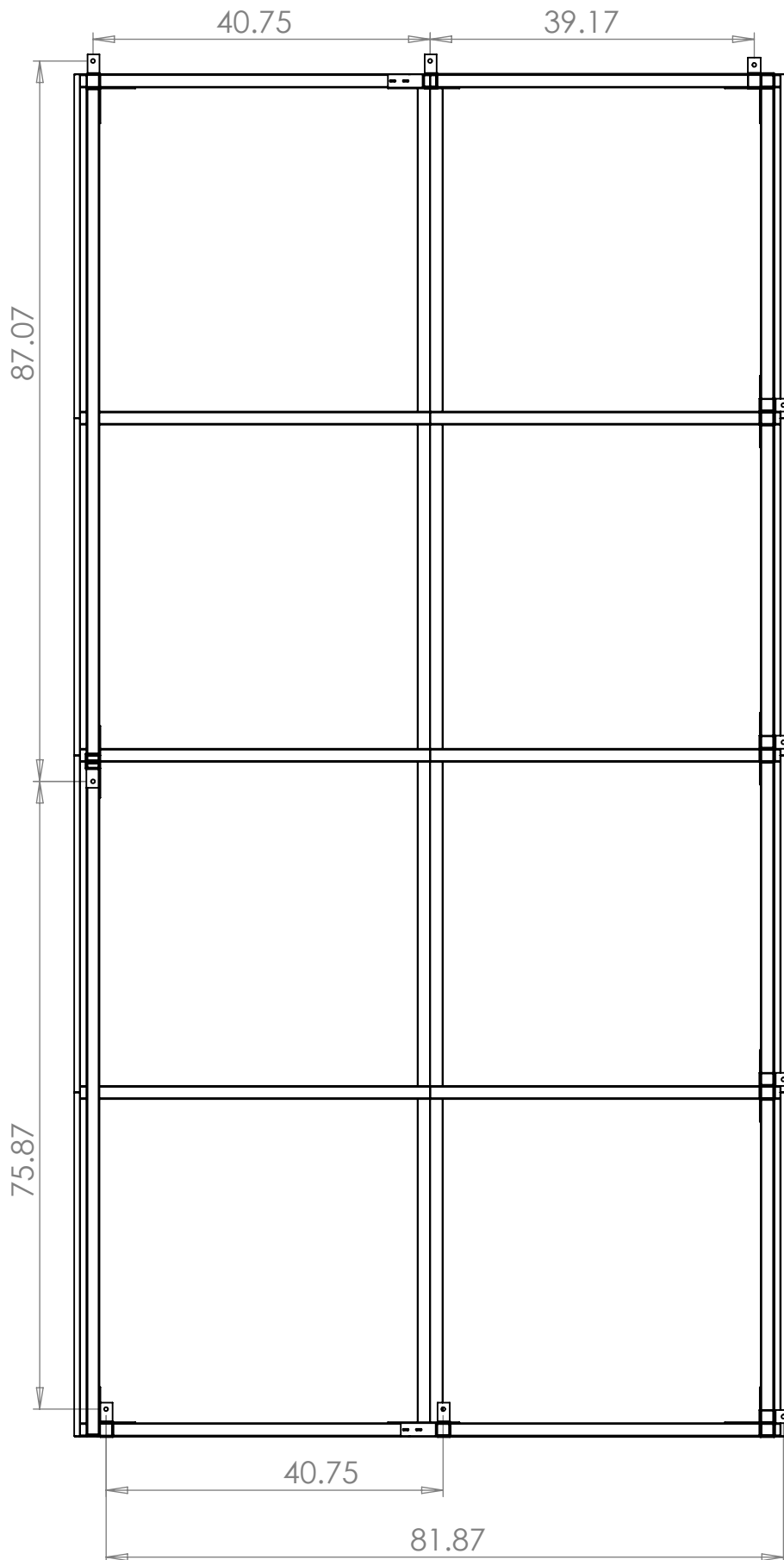

THANK YOU FOR PURCHASING THIS PRODUCT

MAINTENANCE:

To ensure your products give you many years of use we recommend that you:

- Clean panels regularly with soapy water
- Ensure all fittings are tight (for example after a big storm)
- Touch up any exposed metal should it get scratched

CONTACT DETAILS:

Email : Sales@nobutts.com

Web : www.nobutts.com

Tel : 1-888-662-8887

No Butts Bin Company, Inc. 16 Birch Lane, Madison, CT 06443

All Parts and Fixings checked by:	
Print Name:	Signature: