

Assembly Instructions



Email : sales@nobutts.com

Web : www.nobutts.com

Tel : 1-888-662-8887







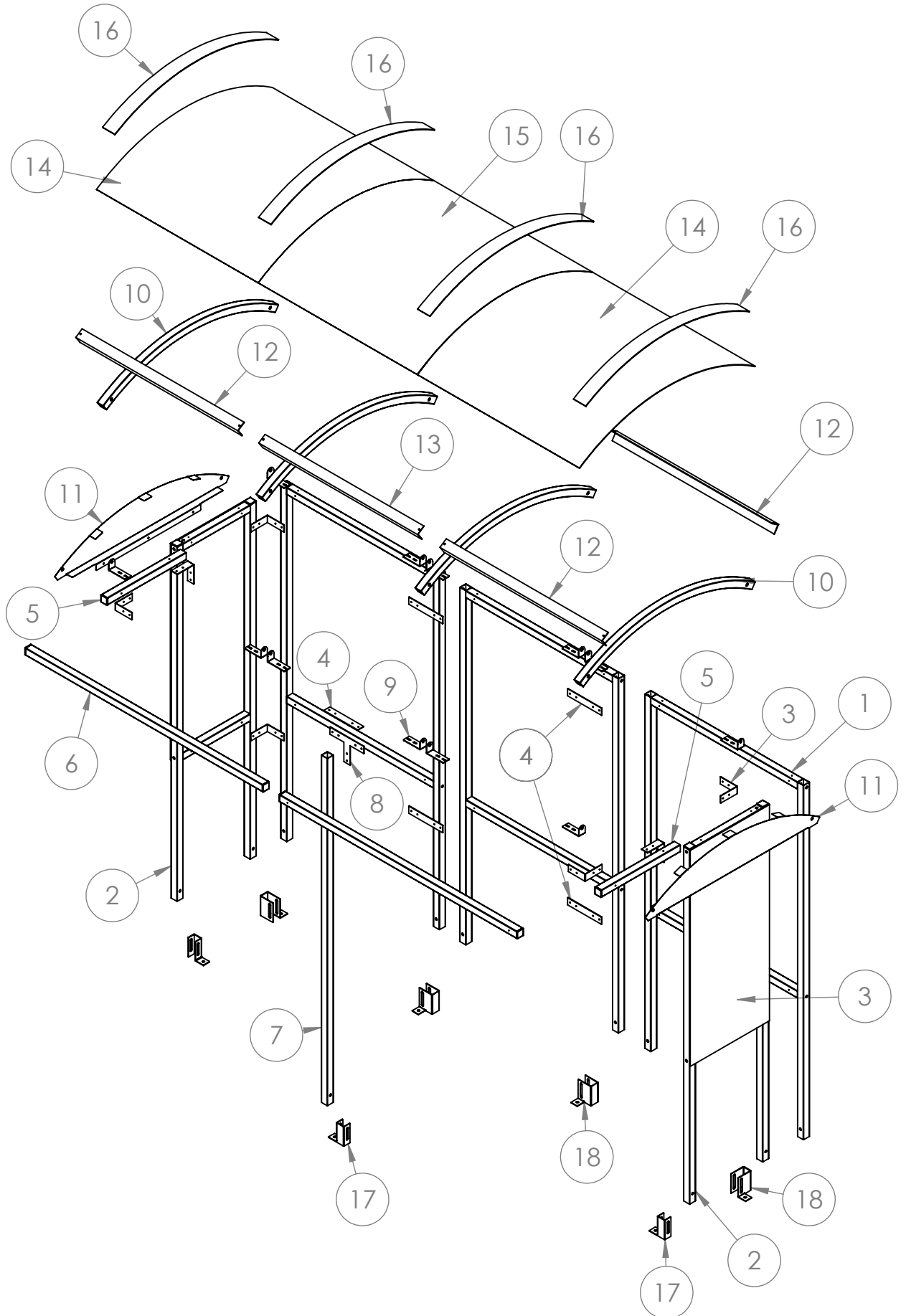

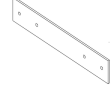
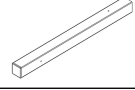
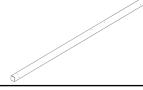
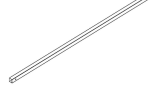

Shelter Type: SR8296

SR8296-01-27102021-USA

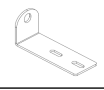
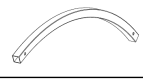

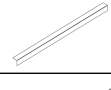
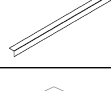
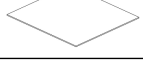

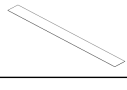
EXPLODED VIEW

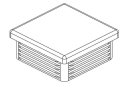

PARTS LIST

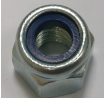
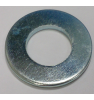
ITEM NO.	PART NO.	DESCRIPTION	Size (inch)	IMAGE	QTY.
1	S1	Frame	78.74 x 40.74		3
2	S3	Frame	78.74 x 20.3		2
3	CB1	Corner Bracket	4.3 x 4.3 x 1.6		8
4	JF1	Straight Bracket	8.7 x 1.6		5
5	ST15	ST15 ROOF TIE BAR	20.15 x 1.57 x 1.57		2
6	ST5	ST5 Roof Tie Bar	60.75		2
7	P5	P5 POST	77.15 x 1.57 x 1.57		1
8	JFT	Bracket	8.66 x 5.9		1
9	DR	Rafter Bracket	4.3 x 1.6 x 2		12
10	DR1R	Rafter	45		4
11	DR1I	Infill Panel	44.6 x 7.9		2
12	DRATO	DR Ally-Angle Trim Outer	2 x 2 x 41.5		4
13	DRATI	DR Ally-Angle Trim Inner	2 x 2 x 40.75		2
14	DR1PO	Roof Panel Outer	47.7 x 41.5		2
15	DR1PI	DR1 Roof Panel Inner	47.6 x 40.75		1
16	DR1T	Roof Trim	47.7 x 3.1		4
17	FT1	Foot Bracket	4.3 x 3.9 x 1.6		3
18	FT3	FT3 Bracket	1.57 x 3.15 x 4.17		4
19	EC40	Plastic end cap	1.6 x 1.6		6

FIXINGS

Fittings	Bolt set M10			T25	T38		BTANCM12100
	M10 x 60mm	Nut	Washer	1" Tech screw	1.5" Tech screw	Black Caps	M10/12 x 100 mm Concrete Bolt
Pack A+B	33	33	66	136	40	66	11
Image							



Drill/Screwdriver

Tools required:



17mm Wrench



Mallet



T25 Torx bit

Step 1 Assemble **S1** and **S3** frames to make up the main structure using **CB1** brackets for the corners and **JF1** brackets for the straight joints. Attach **ST15** tie bars, the **ST3** Tie bars and the **P5** post using **CB**, **JF1** and **JFT** Brackets as shown below.

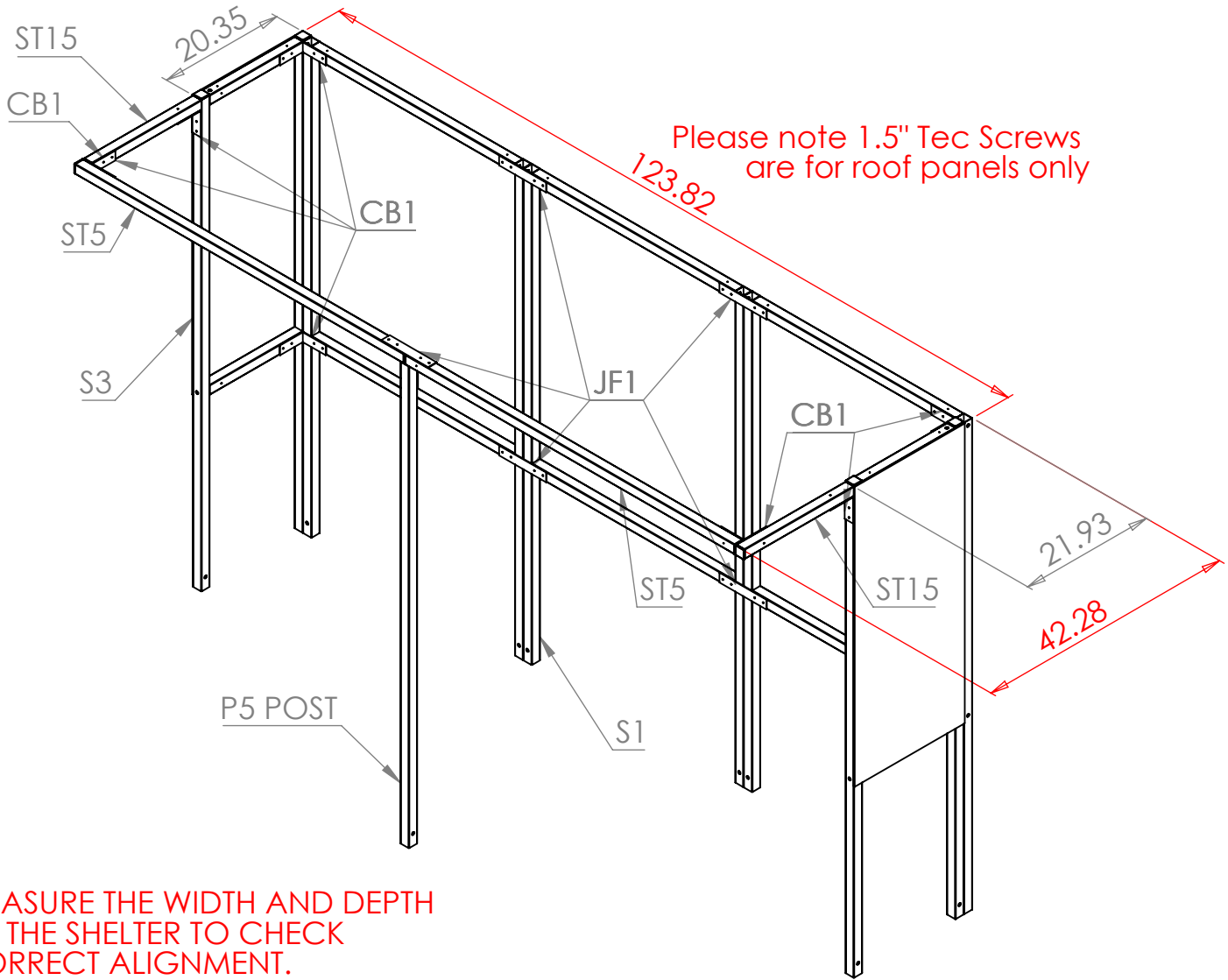

MEASURE THE WIDTH AND DEPTH OF THE SHELTER TO CHECK CORRECT ALIGNMENT.

ENSURE CORRECT ALIGNMENT ON CORNERS

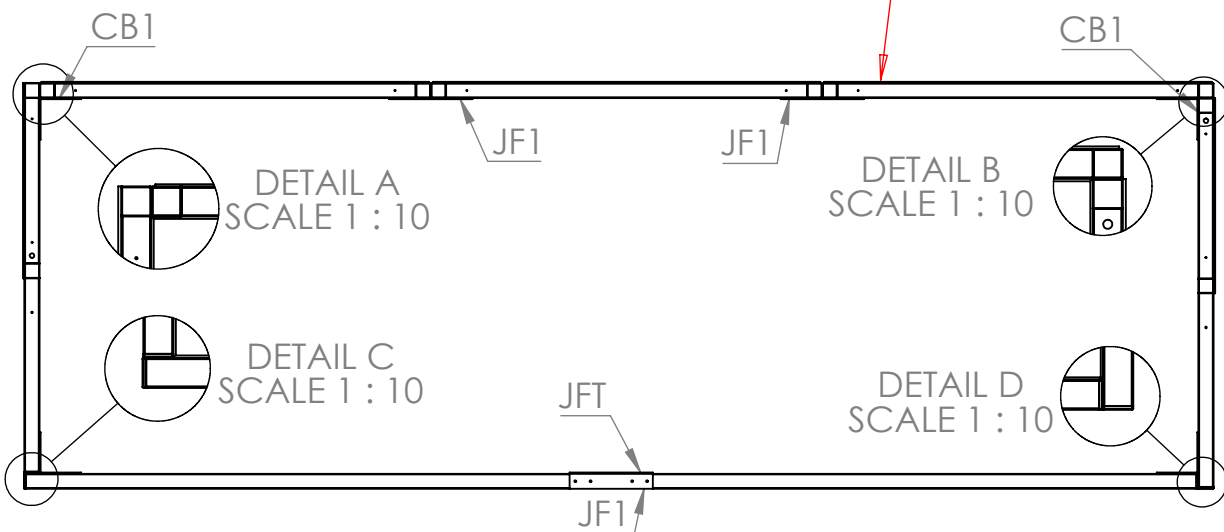

Step 2

Attach **DR1R** rafters using **DR** brackets. Secure the **END PANELS (DR1I)** to frames using 1" tech screws. The end rafters need to be placed in position at the same time as the **DR1I**

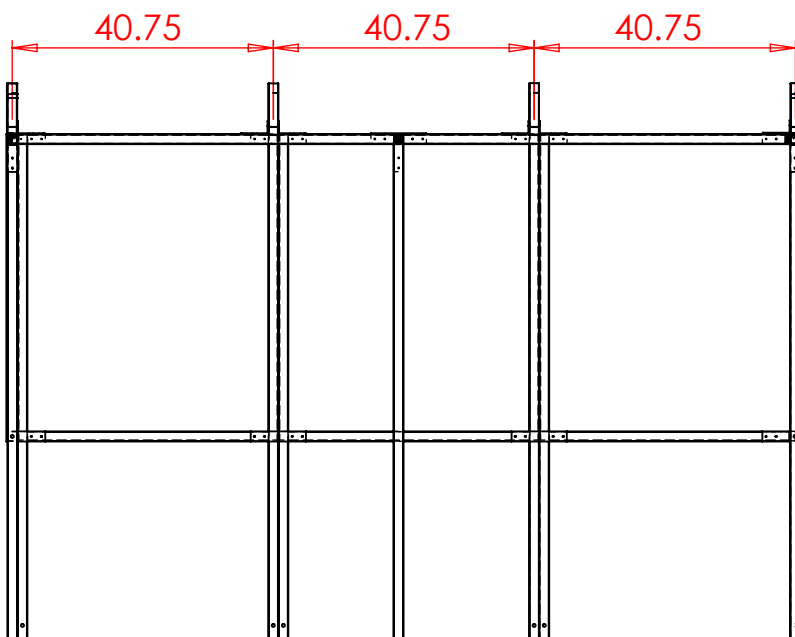
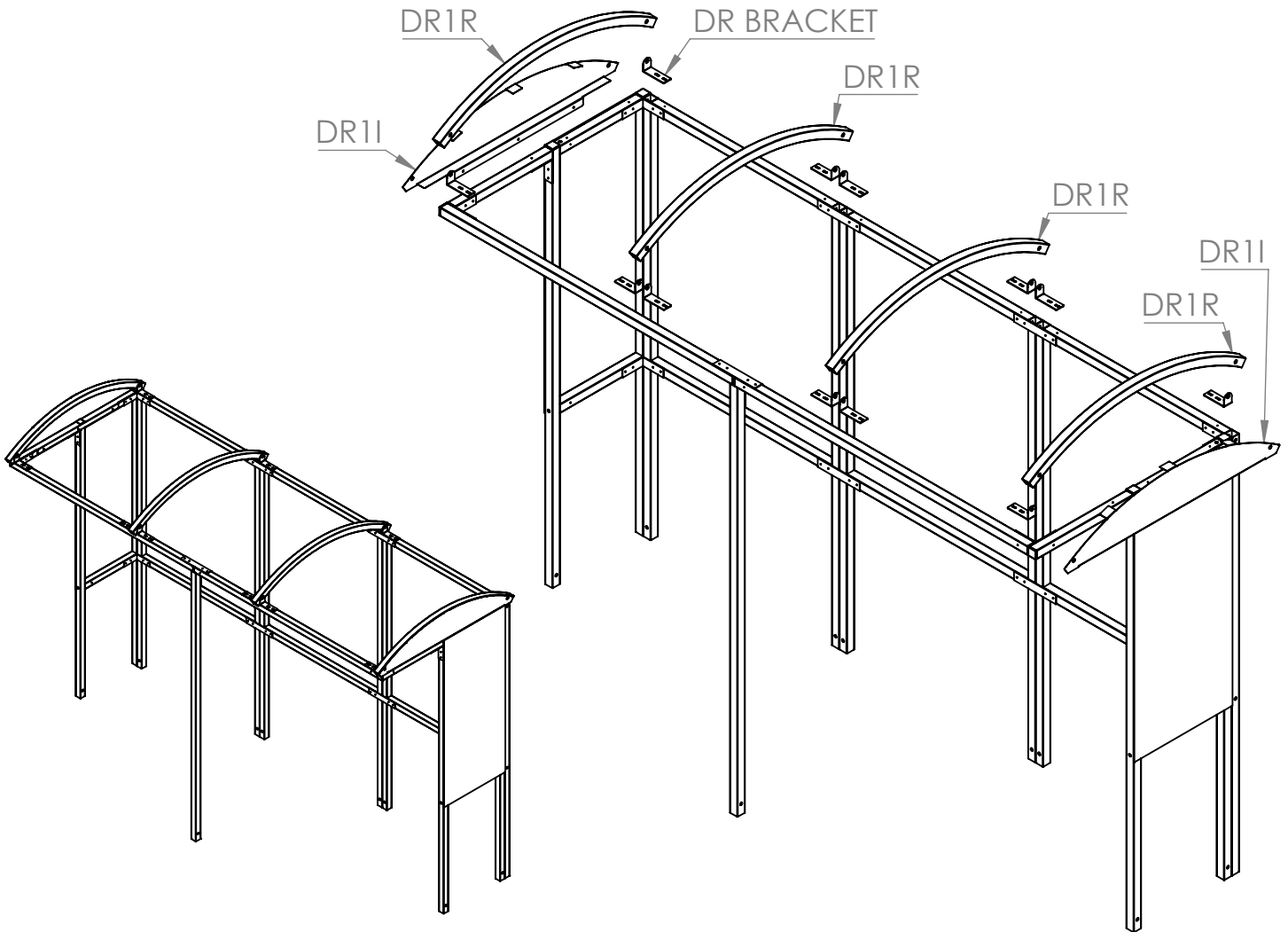

Step 3

Attach the **DR1PO** and **DR1PI** to the top of the rafters with the **DR1PO** on either end and the **DR1PI** in the middle. Seal the gap between the panels using the **DR1T** strips. Then attach the **DRATO** and **DRATI** parts to the lower part of the rafters as shown below.

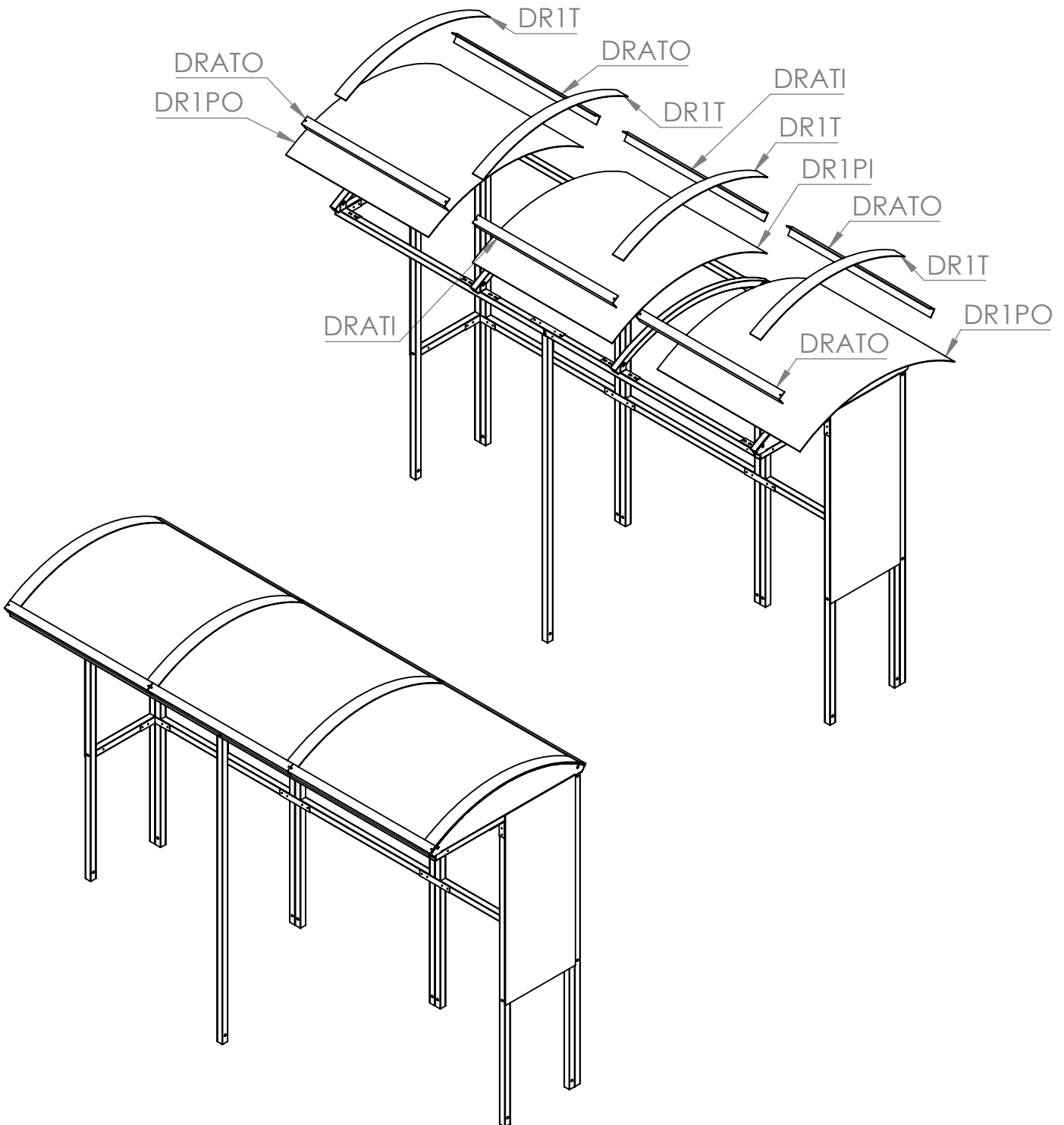

Step 4

Move the shelter into its desired position and attach the foot brackets **FT1/FT3** before fixing in place.

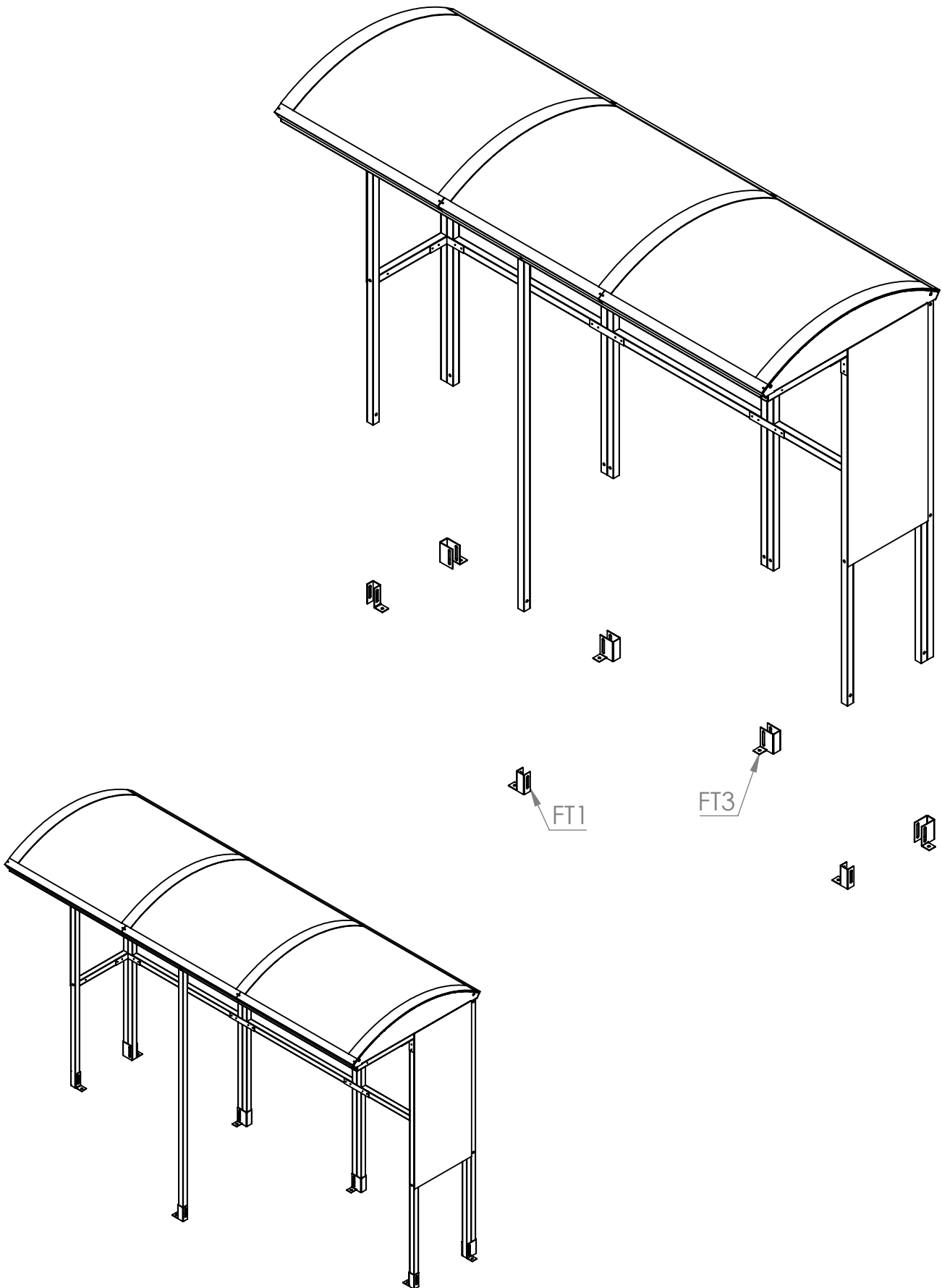

PLAN VIEW

OVERALL DIMENSIONS AND GROUND FIXING POSITIONS
Suggested size for concrete base: 8" oversized on all 4 sides.

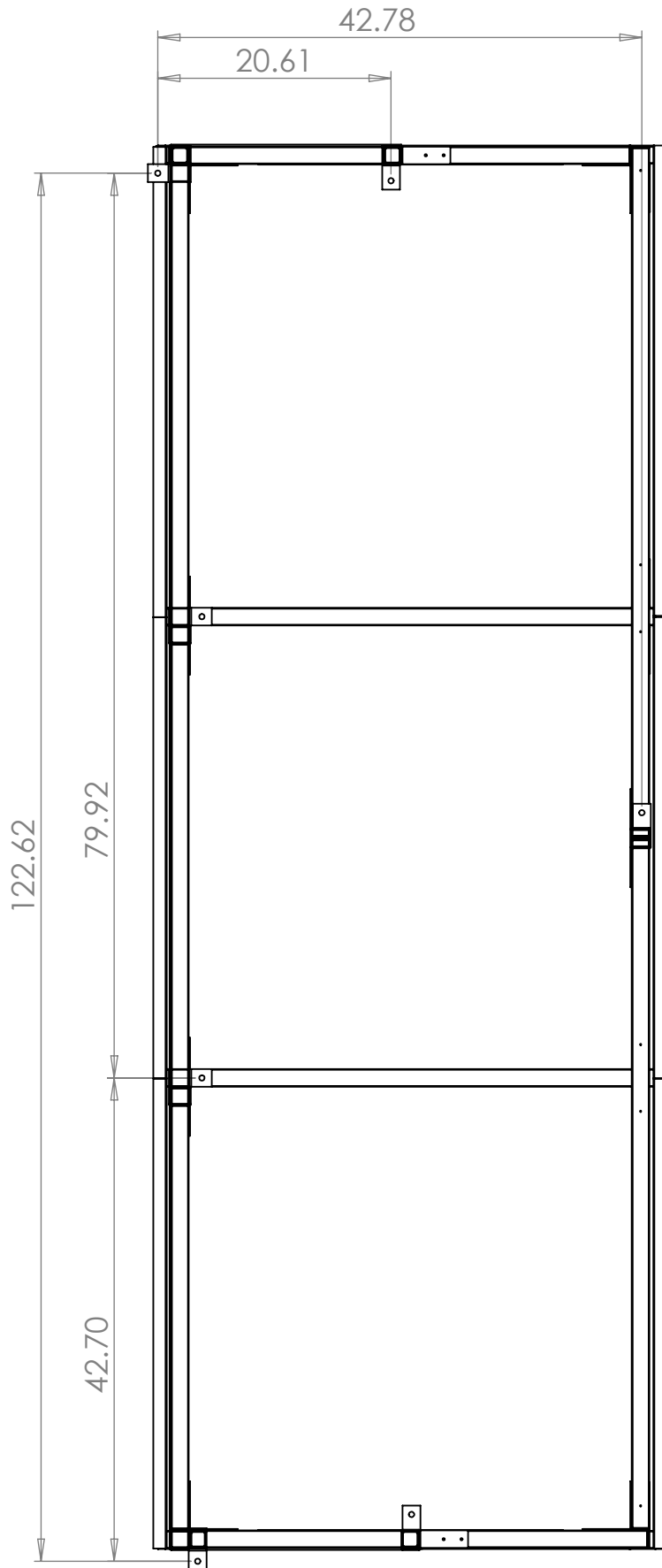

THANK YOU FOR PURCHASING THIS PRODUCT

MAINTENANCE:

To ensure your products give you many years of use we recommend that you:

- Clean panels regularly with soapy water
- Ensure all fittings are tight (for example after a big storm)
- Touch up any exposed metal should it get scratched

CONTACT DETAILS:

Email : Sales@nobutts.com

Web : www.nobutts.com

Tel : 1-888-662-8887

No Butts Bin Company, Inc. 16 Birch Lane, Madison, CT 06443

All Parts and Fixings checked by:	
Print Name:	Signature: