

Assembly Instructions

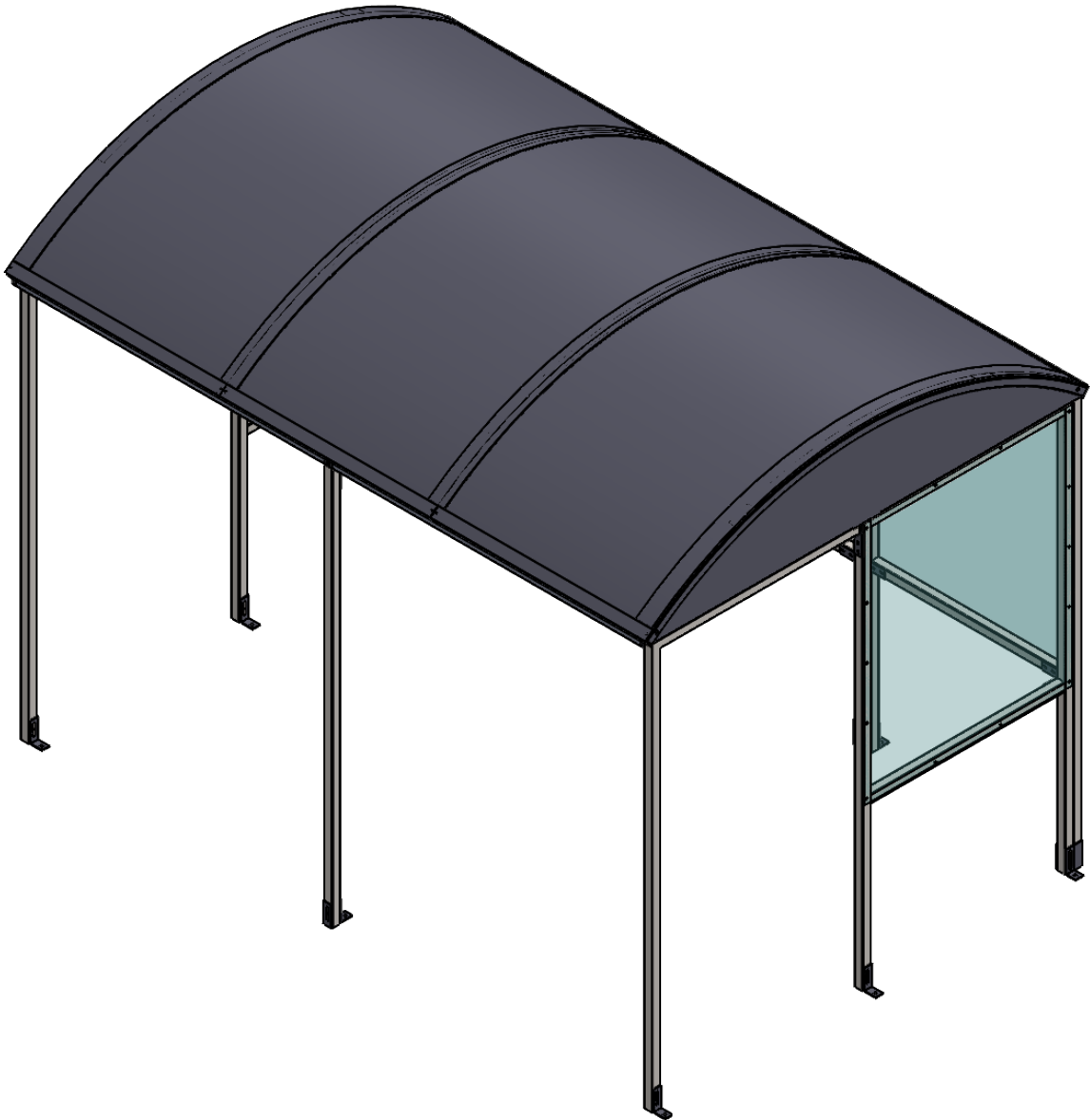

Email : sales@nobutts.com

Web : www.nobutts.com

Tel : 1-888-662-8887







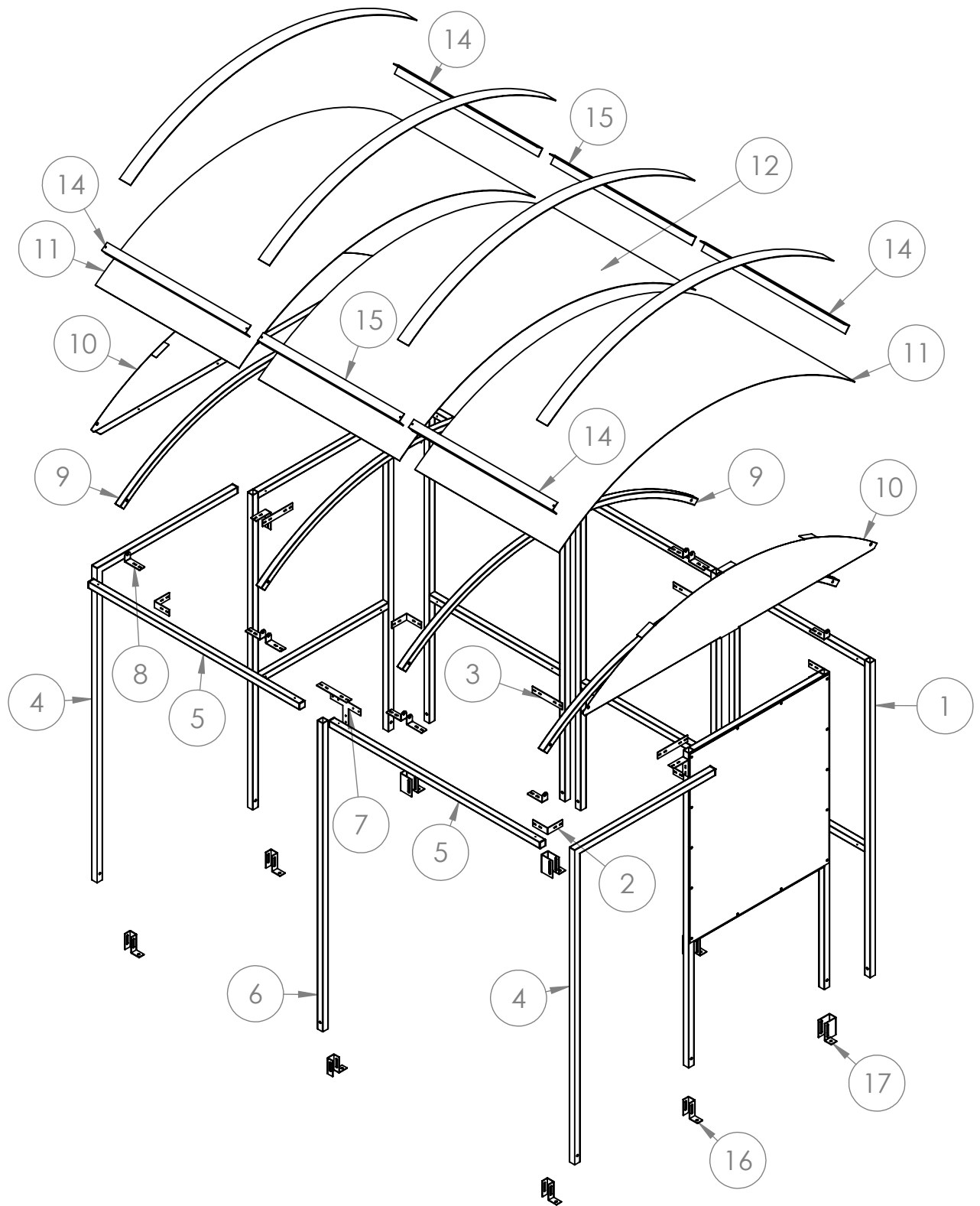





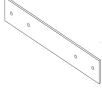
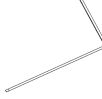

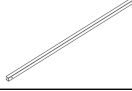
Shelter Type: SR8299

SR8299-01-28102021-USA

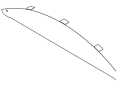

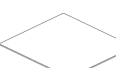

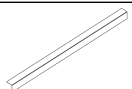
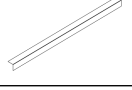
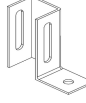
EXPLODED VIEW

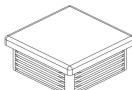

PARTS LIST

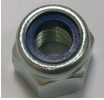
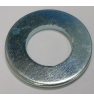
ITEM NO.	PART NO.	DESCRIPTION	Size (inch)	IMAGE	QTY.
1	S1	Full Frame	78.74 x 40.74		5
2	CB1	Corner Bracket - CB1	4.3 x 4.3 x 1.57		8
3	JF1	Joint Flat - JF1	4.33 x 1.57		7
4	P1	Post Frame - P1	78.74 x 40.74		2
5	ST5	ST5 Roof Tie Bar	60.75		2
6	P5	P5 POST	77.15 x 1.57 x 1.57		1
7	JFT	Bracket	8.66 x 5.9		1
8	DR	Rafter Bracket	4.3 x 1.6 x 2		12
9	DR2R	DR2R Rafter	92.32		4
10	DR2I	DR2 infill panel	85 x 15.75		2
11	DR2PO	DR2 Roof Panel Outer	92.32 x 41.54		2
12	DR2PI	DR2 Roof Panel Inner	40.75 x 92.30		1
13	DR2T	DR2 Roof Trim	92.32 x 3.15		4
14	DRATO	DR Ally-Angle Trim Outer	2 x 2 x 41.5		4
15	DRATI	DR Ally-Angle Trim Inner	2 x 2 x 40.75		2
16	FT1	FT1 BRACKET	1.57 x 1.57 x 3.94		5
17	FT3	FT3 Bracket	1.57 x 3.15 x 4.17		4
18	EC40	Plastic end cap	1.6 x 1.6		6

FIXINGS

Fittings	Bolt set M10			T25	T38		BTANCM12100
	M10 x 60mm	Nut	Washer	1" Tech screw	1.5" Tech screw	Black Caps	M10/12 x 100 mm Concrete Bolt
Pack A+B	33	33	66	136	40	66	11
Image							



Drill/Screwdriver

Tools required:



17mm Wrench



Mallet



T25 Torx bit

Step 1 Assemble **S1** frames to make up the main structure using **CB1** brackets for the corners and **JF1** brackets for the straight joints. Attach **P1** post to the S1C Frame using **CB1** and **JF1** brackets as shown below.

Please note 1.5" Tec Screws are for roof panels only

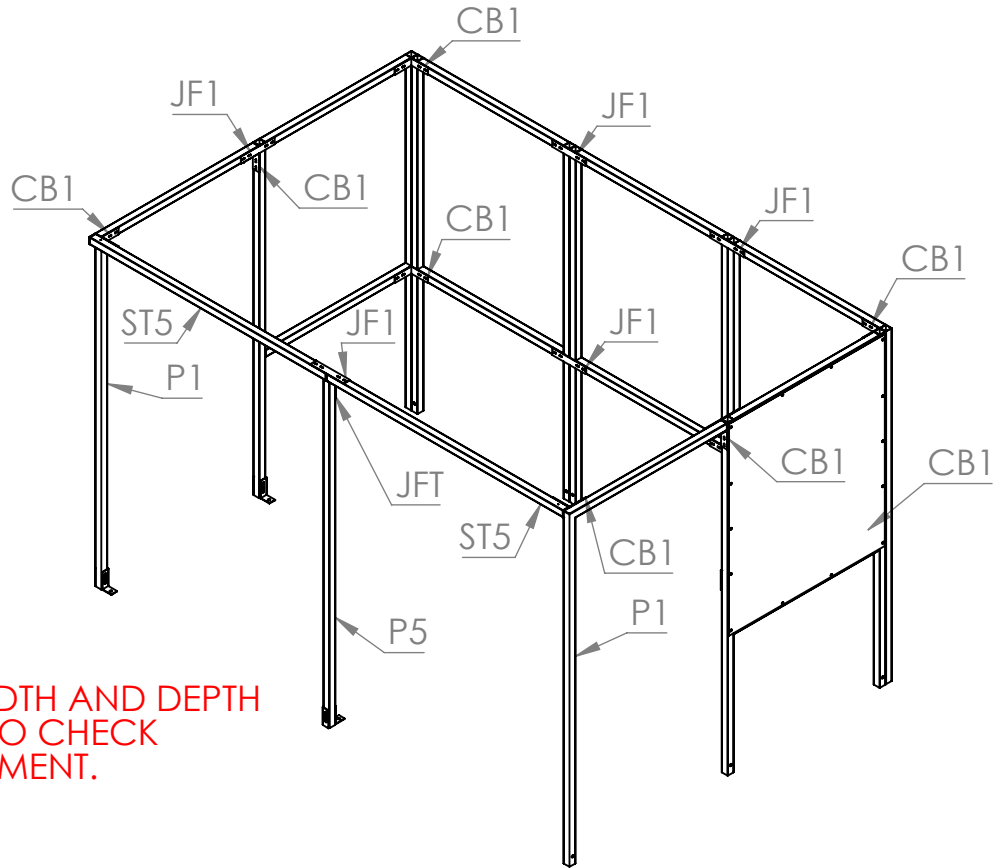

MEASURE THE WIDTH AND DEPTH OF THE SHELTER TO CHECK CORRECT ALIGNMENT.

ENSURE CORRECT ALIGNMENT ON CORNERS

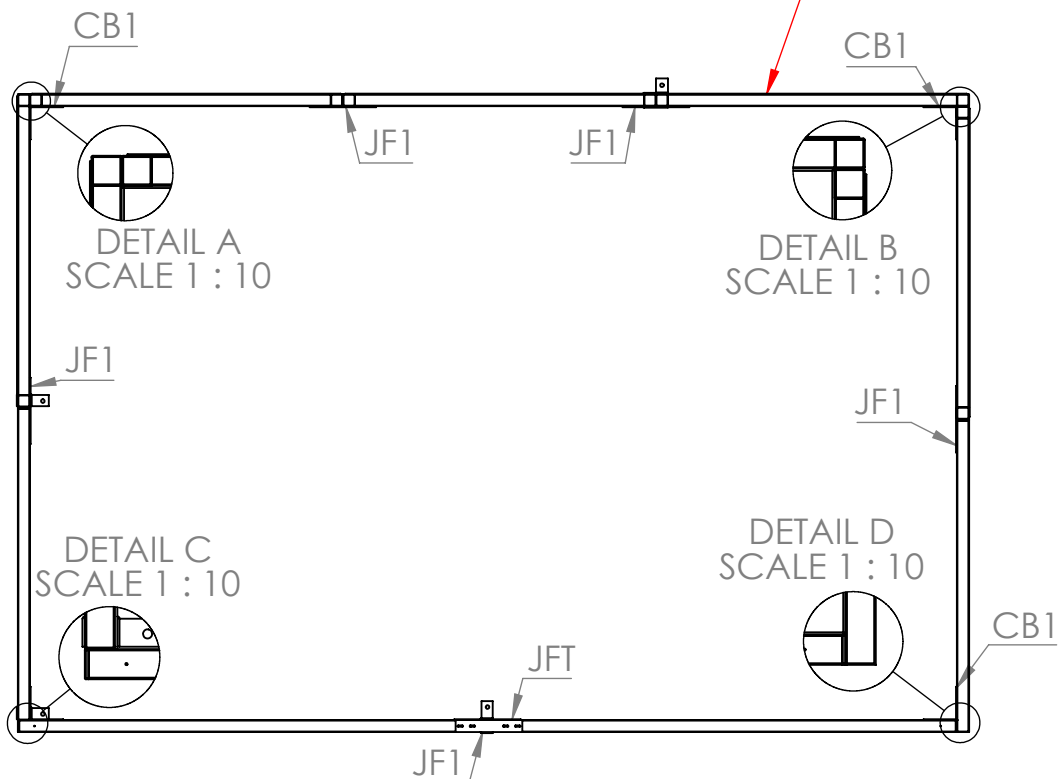

Step 2

Attach **DR2R** rafters using **DR** brackets. Secure the **END PANELS (DR2I)** to frames using tec screws. The end rafters need to be placed in position at the same time as the **DR2I**

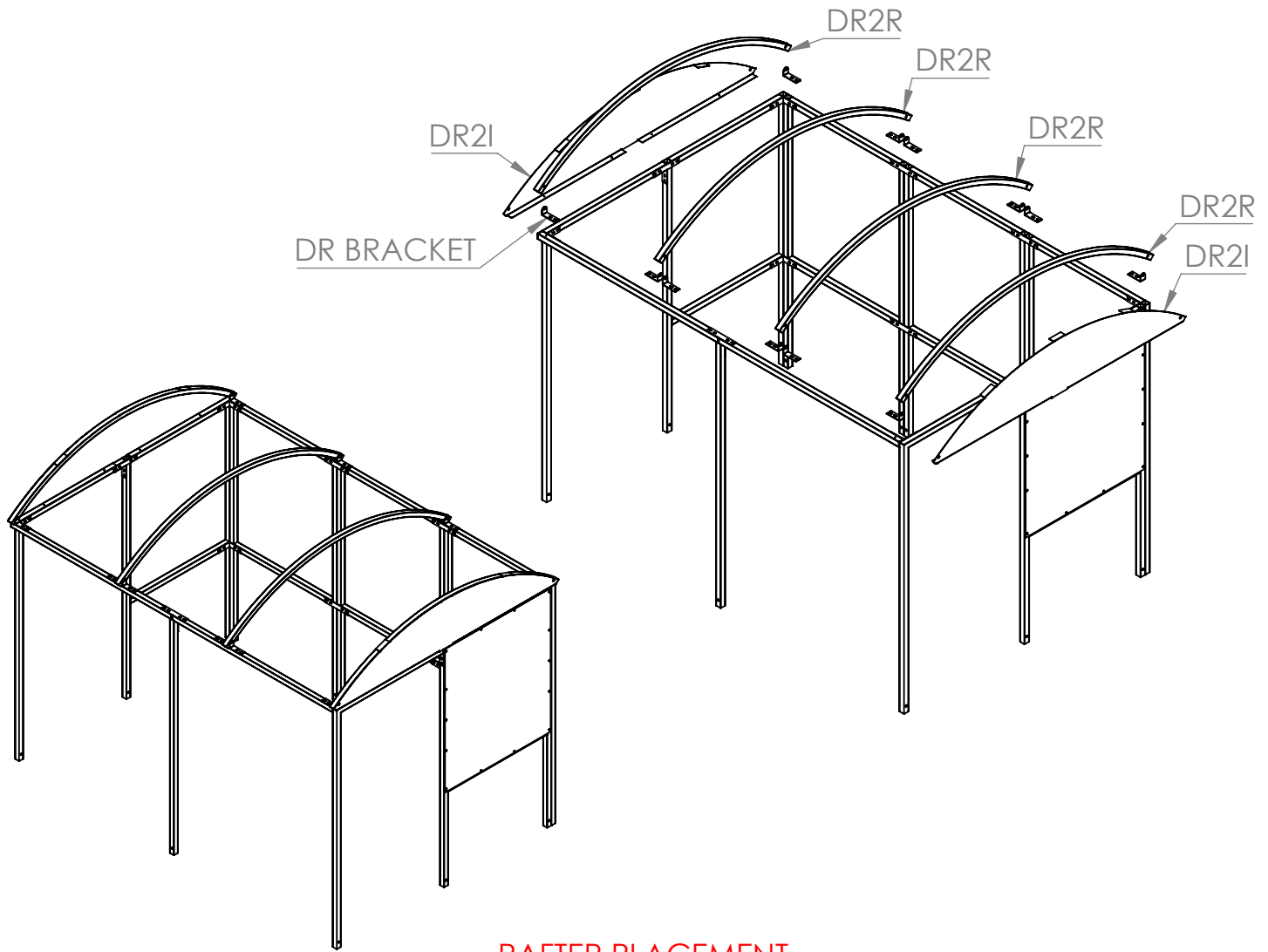

RAFTER PLACEMENT

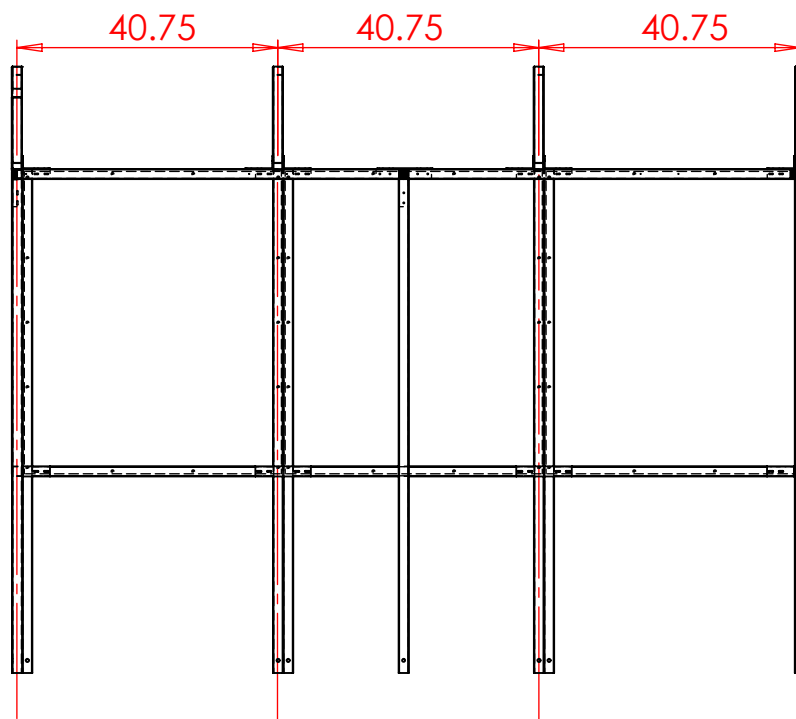

Step 3

Attach the **DR2PO** and **DR2PI** Panels to the top of the rafters, with the **DR2PO** on either end and the **DR2PI** in between. Seal the gap between the panels using the **DR2T** strips. Attach the **DRATO** and **DRATI** Trim parts to the lower part of the rafters as shown below.

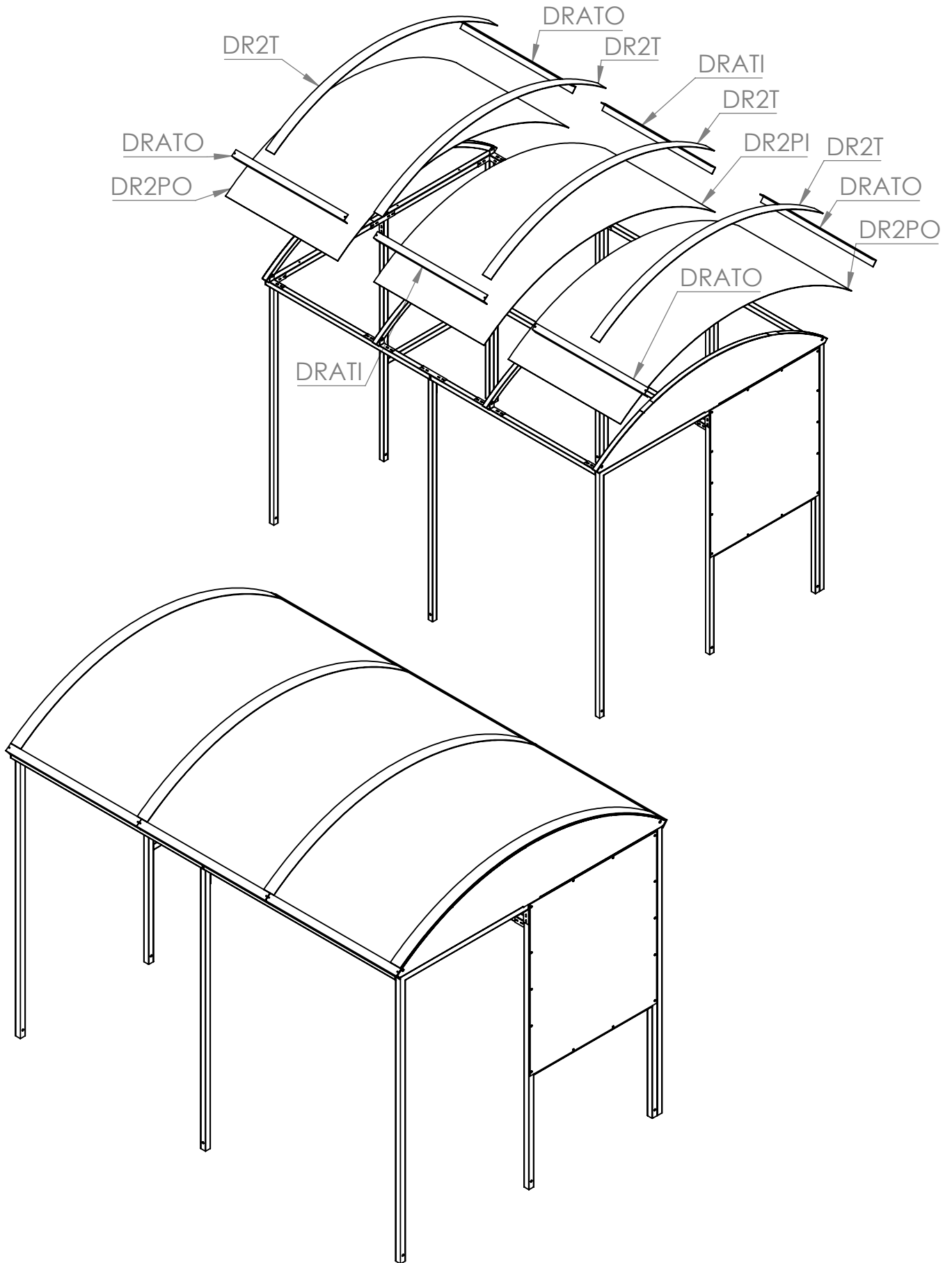

Step 4

Move the shelter into its desired position and attach the foot brackets **FT1/FT3** before fixing in place.

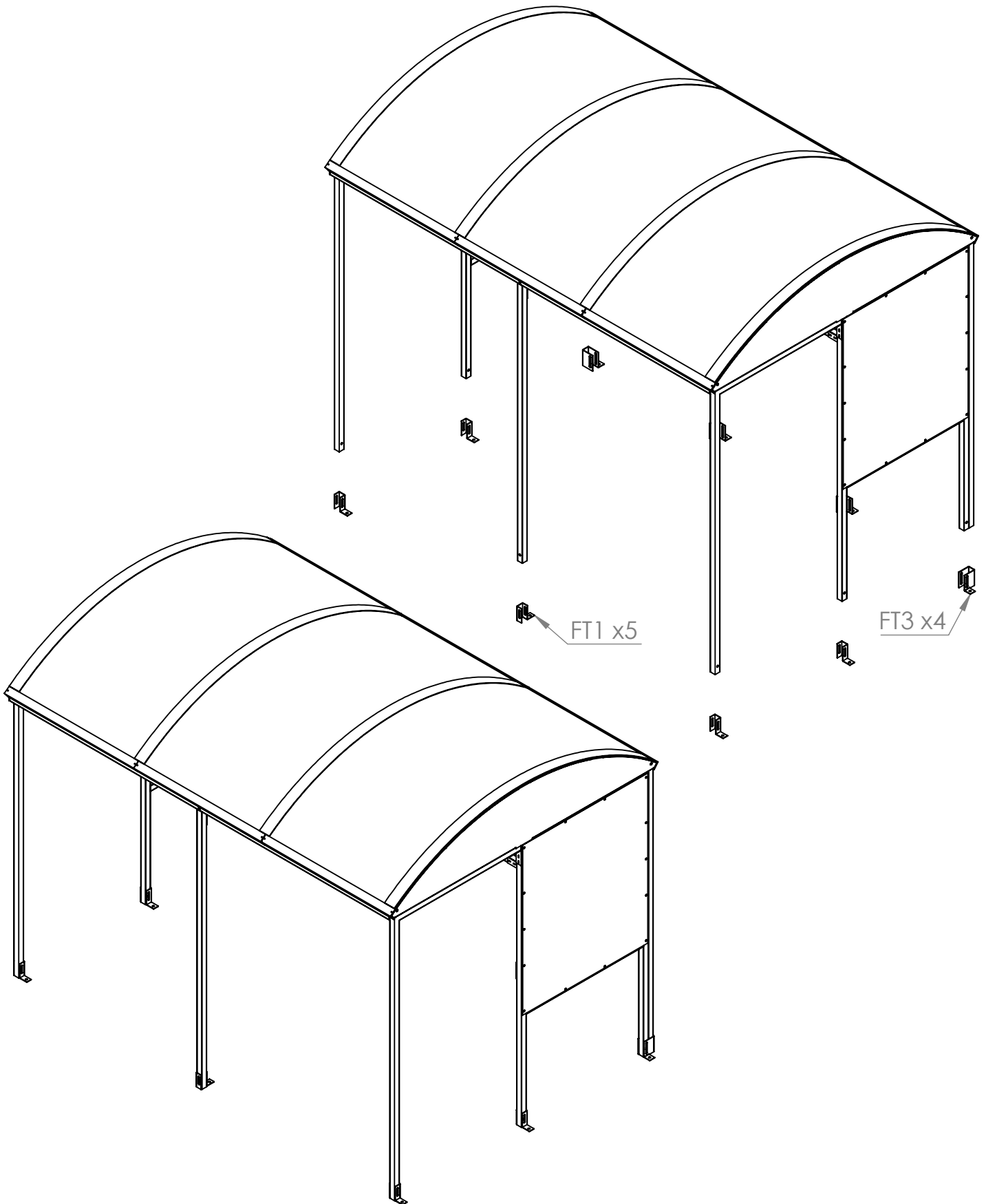

PLAN VIEW

OVERALL DIMENSIONS AND GROUND FIXING POSITIONS
Suggested size for concrete base: 8" oversized on all 4 sides.

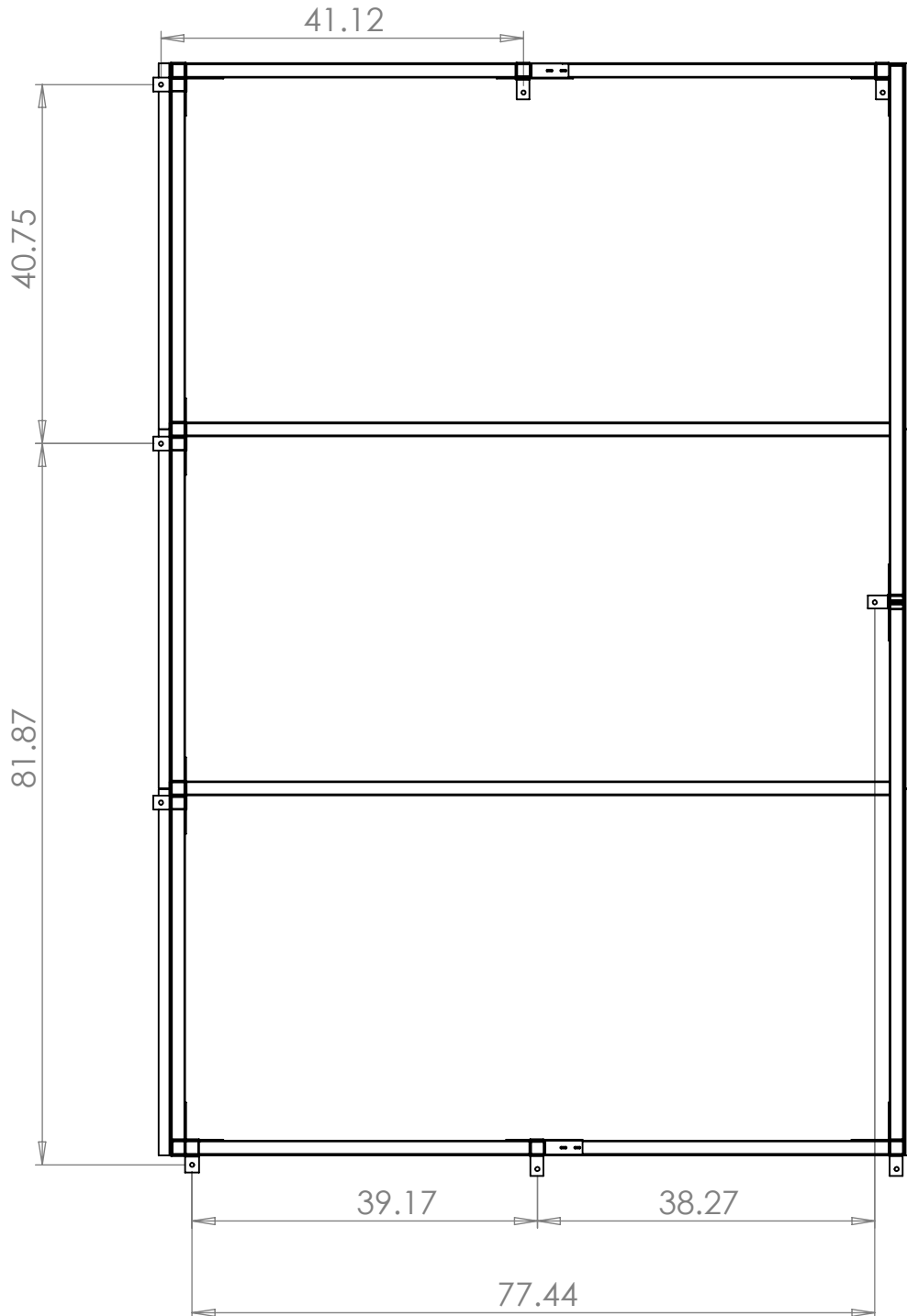

THANK YOU FOR PURCHASING THIS PRODUCT

MAINTENANCE:

To ensure your products give you many years of use we recommend that you:

- Clean panels regularly with soapy water
- Ensure all fittings are tight (for example after a big storm)
- Touch up any exposed metal should it get scratched

CONTACT DETAILS:

Email : Sales@nobutts.com

Web : www.nobutts.com

Tel : 1-888-662-8887

No Butts Bin Company, Inc. 16 Birch Lane, Madison, CT 06443

All Parts and Fixings checked by:	
Print Name:	Signature: