

Assembly Instructions



Email : sales@nobutts.com

Web : www.nobutts.com

Tel : 1-888-662-8887







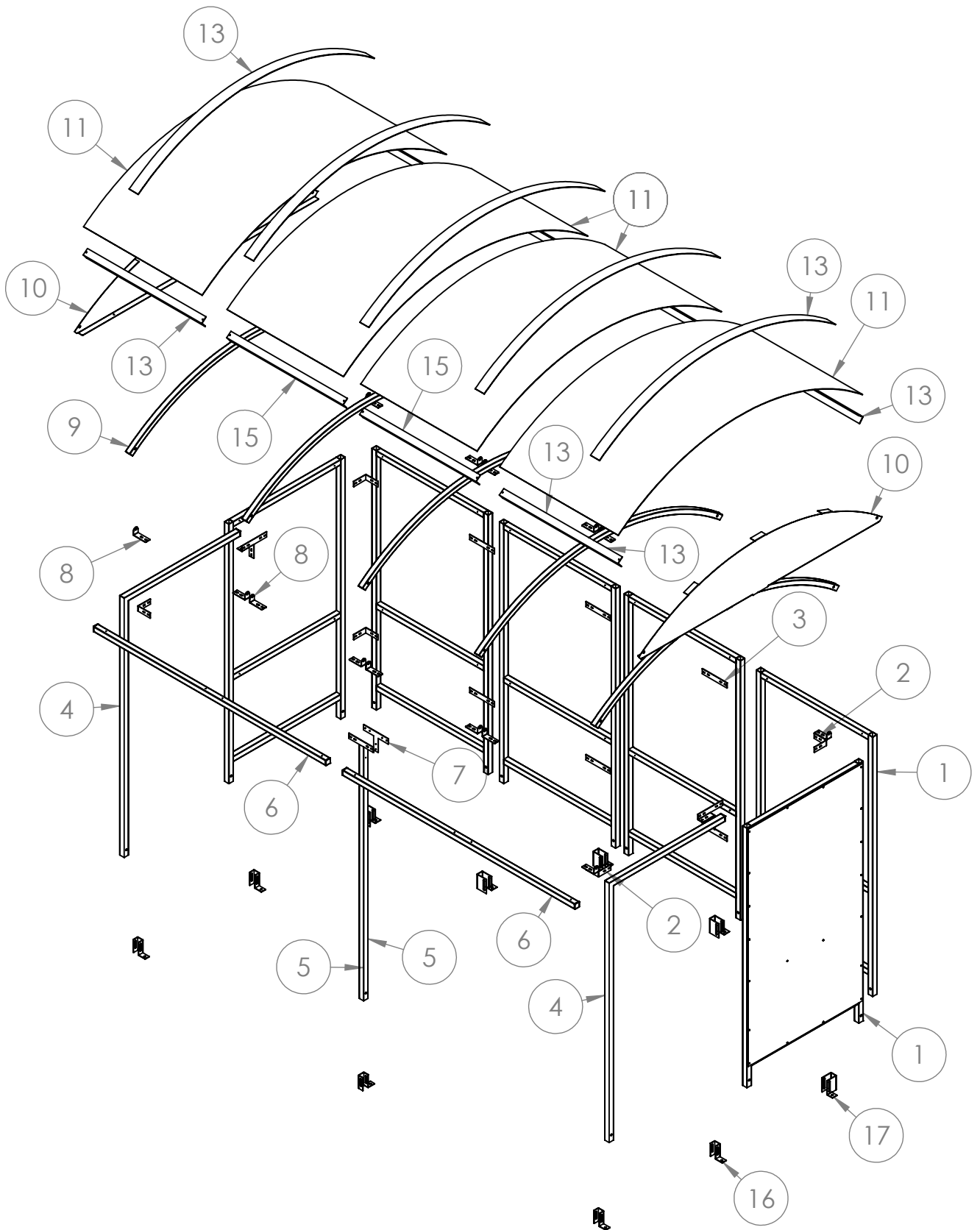



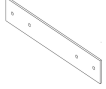

Shelter Type: SR8300-F

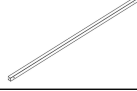
SR8300-F-01-29102021-USA



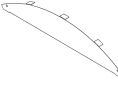
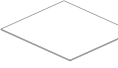
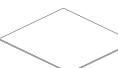

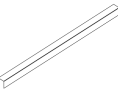
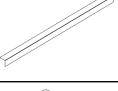
EXPLODED VIEW

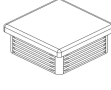

PARTS LIST

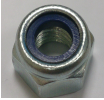
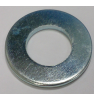
ITEM NO.	PART NO.	DESCRIPTION	Size (inch)	IMAGE	QTY.
1	S1C	S1 - Full Frame - SRC	78.74 x 40.74		6
2	CB1	Corner Bracket - CB1	4.3 x 4.3 x 1.57		8
3	JF1	Joint Flat - JF1	4.33 x 1.57		9
4	P1	Post Frame - P1	78.74 x 40.74		2
5	P5	P5 POST	77.15 x 1.57 x 1.57		1
6	ST3	Roof Tie	81.1 x 1.57 x 1.57		2
7	JFT	Bracket	8.66 x 5.9		1
8	DR	Rafter Bracket	4.3 x 1.6 x 2		16
9	DR2R	DR2R Rafter	92.32		5
10	DR2I	DR2 infill panel	85 x 15.75		2
11	DR2PO	DR2 Roof Panel Outer	92.32 x 41.54		2
11	DR2PI	DR2 Roof Panel Inner	40.75 x 92.30		2
13	DR2T	DR2 Roof Trim	92.32 x 3.15		5
13	DRATO	DR Ally-Angle Trim Outer	2 x 2 x 41.5		4
15	DRATI	DR Ally-Angle Trim Inner	2 x 2 x 40.75		4
16	FT1	FT1 BRACKET	1.57 x 1.57 x 3.94		5
17	FT3	FT3 Bracket	1.57 x 3.15 x 4.17		5
18	EC40	Plastic end cap	1.6 x 1.6		6

FIXINGS

Fittings	Bolt set M10			T25	T38		BTANCM12100
	M10 x 60mm	Nut	Washer	1" Tech screw	1.5" Tech screw	Black Caps	M10/12 x 100 mm Concrete Bolt
Pack A+B	33	33	66	136	40	66	11
Image							



Drill/Screwdriver

Tools required:



17mm Wrench



Mallet



T25 Torx bit

Step 1 Assemble **S1C** frames to make up the main structure using **CB1** brackets for the corners and **JF1** brackets for the straight joints. Attach **P1** post to the **S1C** Frame using **CB1** and **JF1** brackets as shown below. Assemble the **ST3** Roof ties and the **P5** Post using the **JFT** and **JF1** brackets.

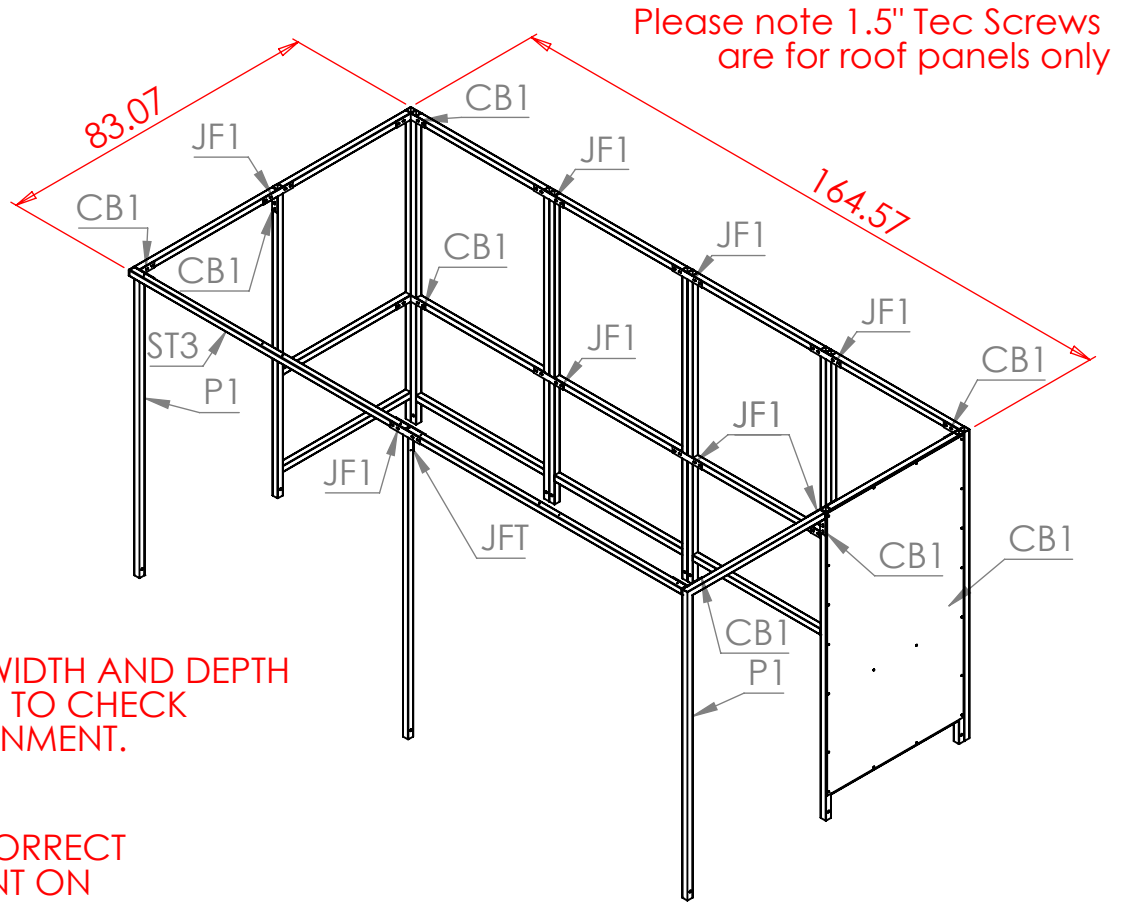

MEASURE THE WIDTH AND DEPTH OF THE SHELTER TO CHECK CORRECT ALIGNMENT.

ENSURE CORRECT ALIGNMENT ON CORNERS

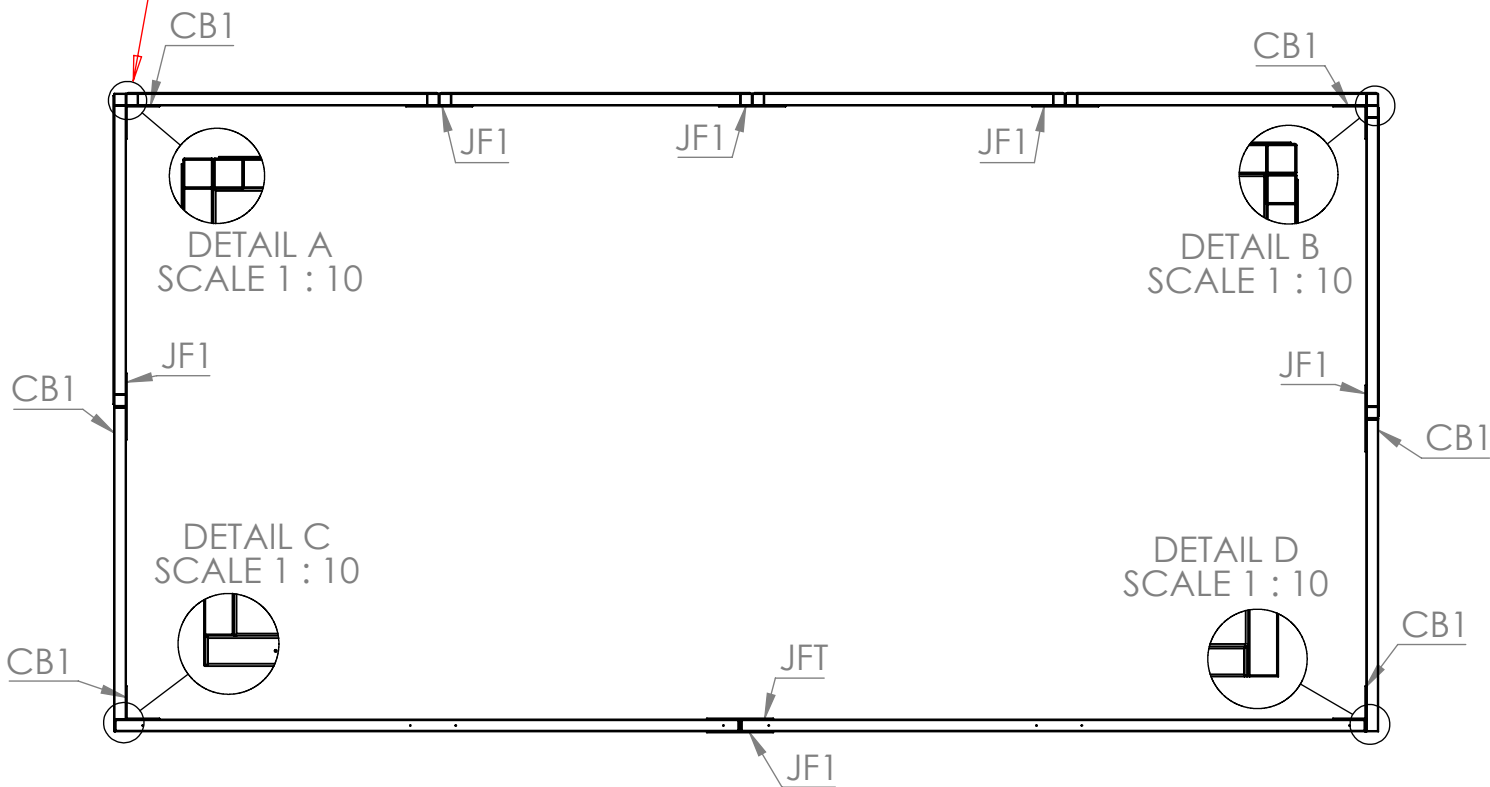

Step 2

Attach **DR2R** rafters using **DR** brackets. Secure the **END PANELS (DR2I)** to frames using 1" tech screws. The end rafters need to be placed in position at the same time as the **DR2I**

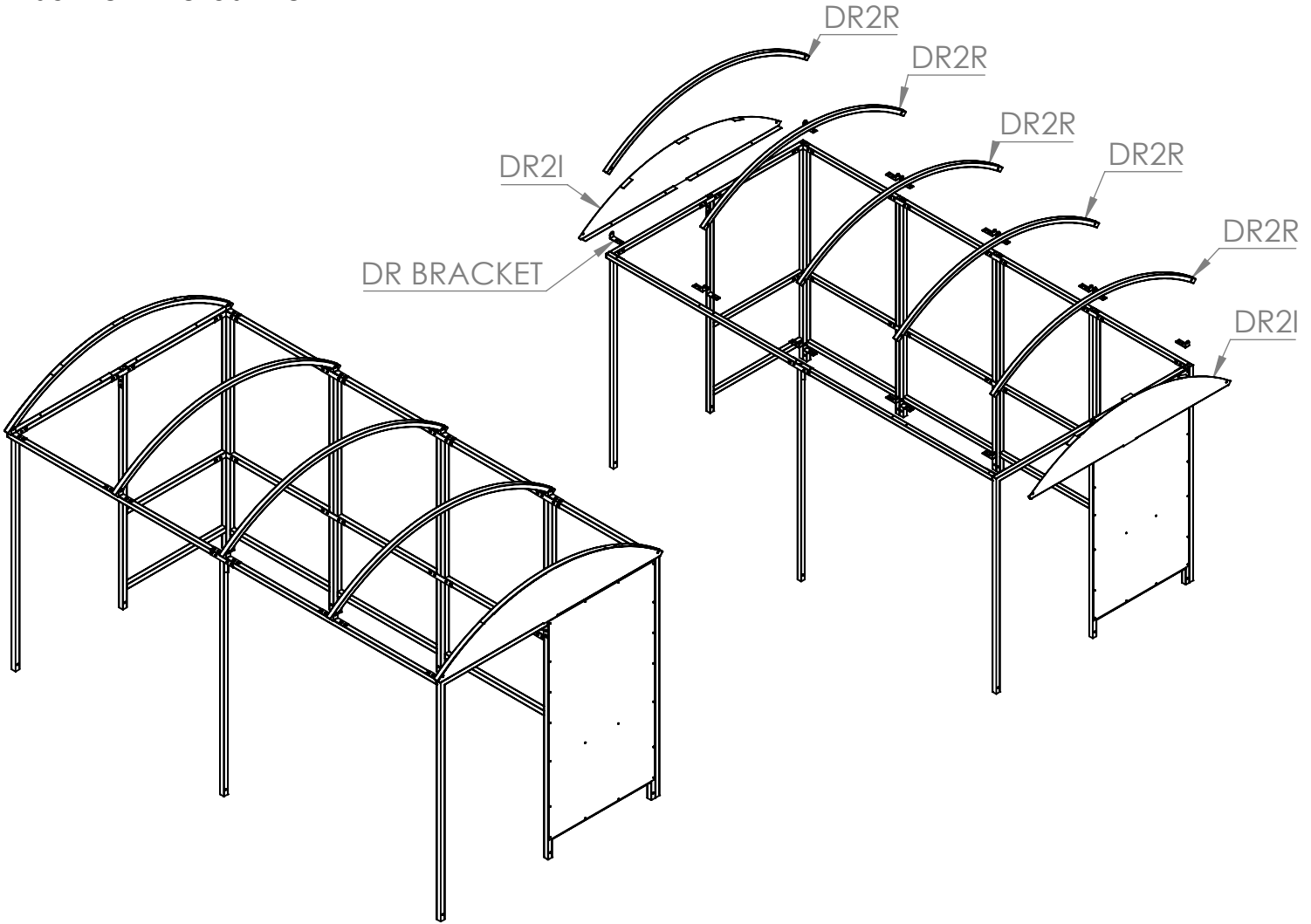

RAFTER PLACEMENT

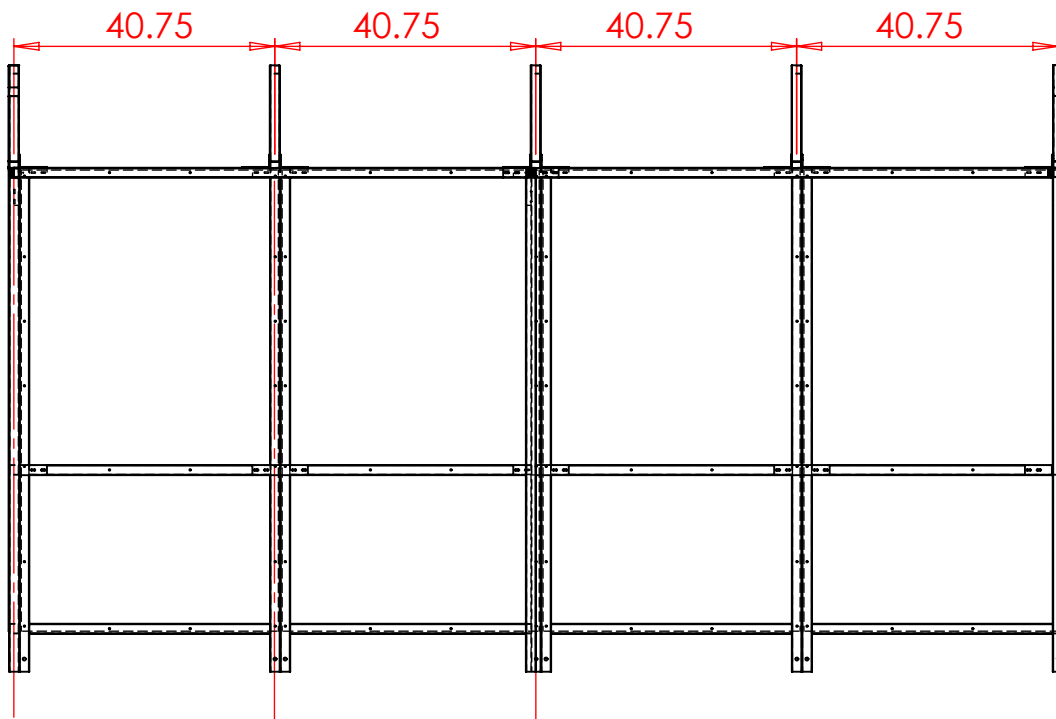

Step 3

Attach the **DR2PO** and **DR2PI** Panels to the top of the rafters, with the **DR2PO** on either end and the **DR2PI** in between. Seal the gap between the panels using the **DR2T** strips. Attach the **DRATO** and **DRATI** Trim parts to the lower part of the rafters as shown below.

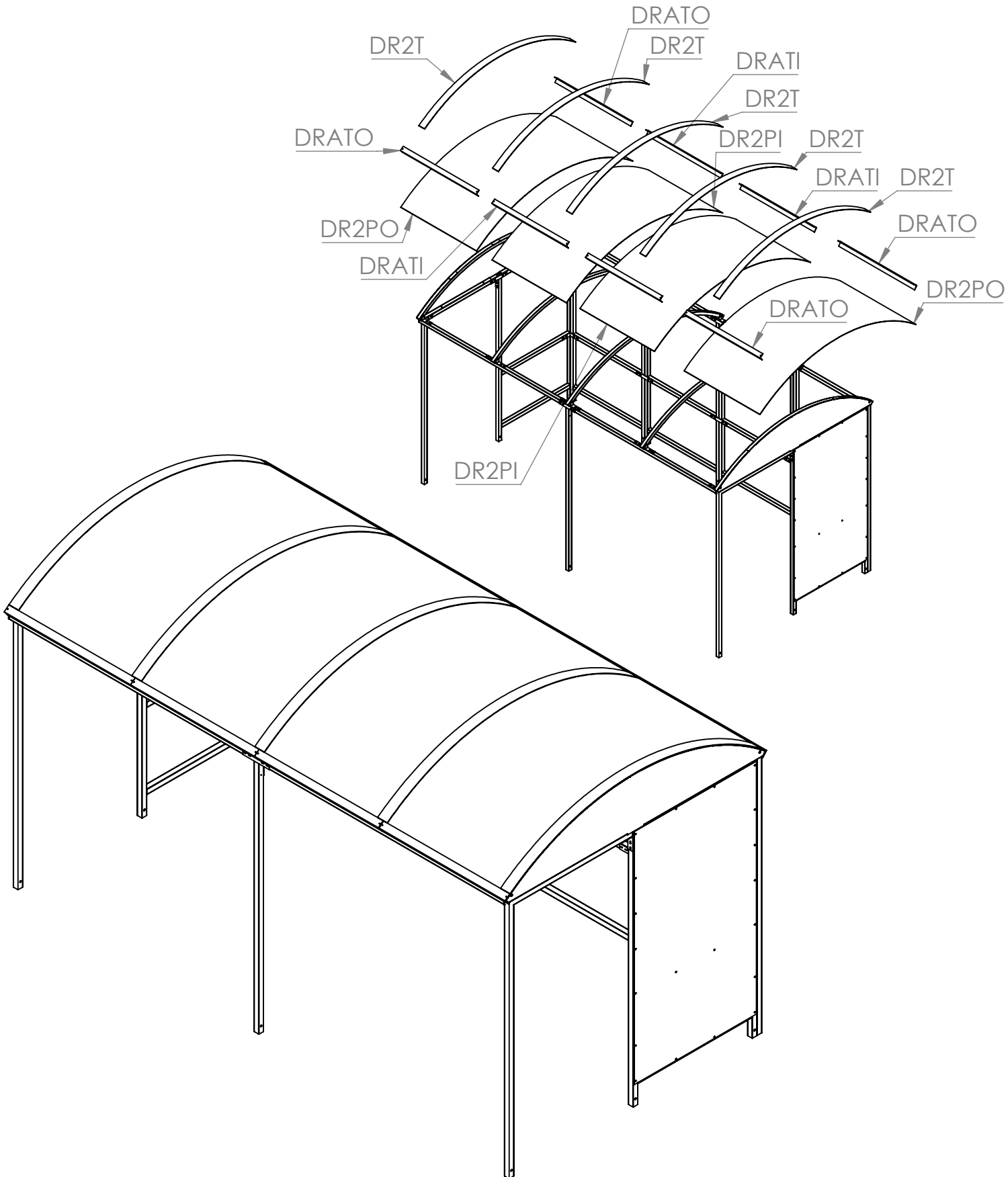

Step 4

Move the shelter into its desired position and attach the foot brackets **FT1/FT3** before fixing in place.

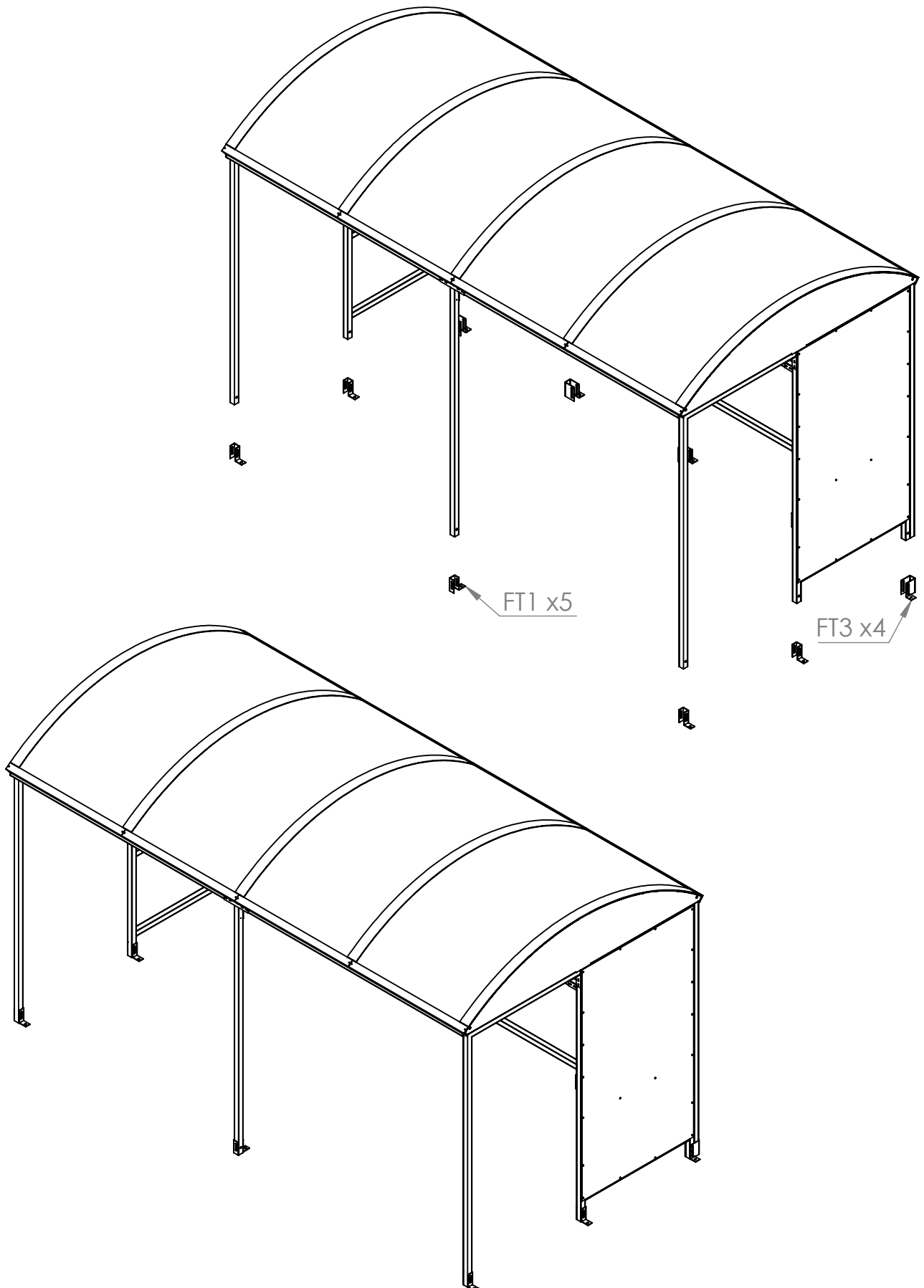

PLAN VIEW

OVERALL DIMENSIONS AND GROUND FIXING POSITIONS
Suggested size for concrete base: 8" oversized on all 4 sides.

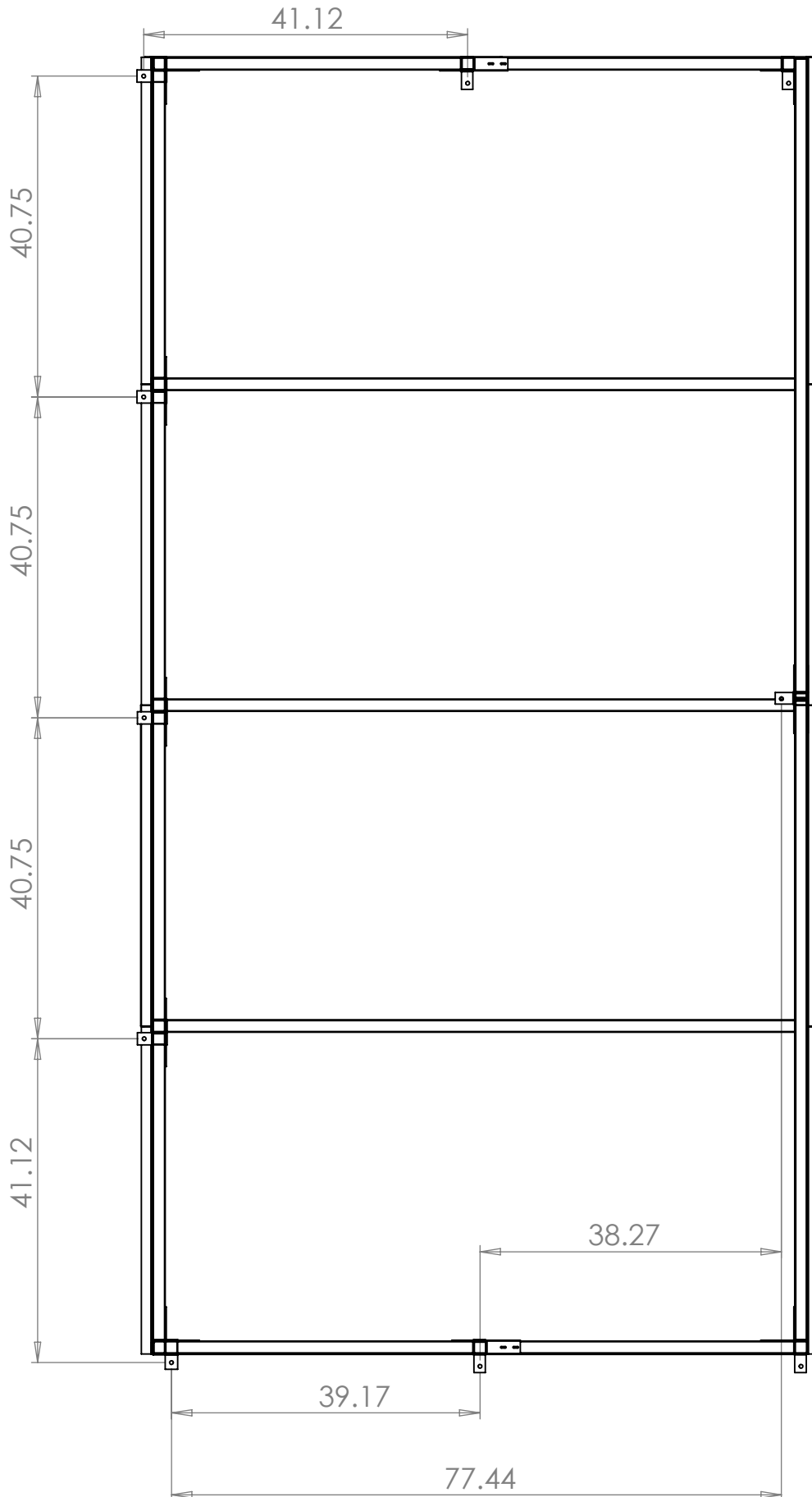

THANK YOU FOR PURCHASING THIS PRODUCT

MAINTENANCE:

To ensure your products give you many years of use we recommend that you:

- Clean panels regularly with soapy water
- Ensure all fittings are tight (for example after a big storm)
- Touch up any exposed metal should it get scratched

CONTACT DETAILS:

Email : Sales@nobutts.com

Web : www.nobutts.com

Tel : 1-888-662-8887

No Butts Bin Company, Inc. 16 Birch Lane, Madison, CT 06443

All Parts and Fixings checked by:	
Print Name:	Signature: